

# DIGITAL MASTER

780

## USER GUIDE V4.0



*Simon Brown, HB9DRV*

Last update: Friday, May 30, 2008

Sponsor:



Martin Lynch and Sons of London supplies all radios used by HB9DRV and GD4ELI.

Special thanks are due to Chris Taylor for his friendly and efficient service.



If you are looking for a new radio to use with digital mode software I recommend Kenwood's TS-480SAT. It offers excellent value for money, is very easy to use and has the best computer support available today.

# Contents

<b>Introduction .....</b>	<b>7</b>
Supported Modes .....	7
Operating System Support .....	8
VISTA .....	8
Hardware Requirement .....	8
Meet The Users .....	9
<b>Getting Started .....</b>	<b>11</b>
Audio Interfacing .....	11
Commercial Solutions .....	11
DIY .....	12
Tags .....	13
Soundcard .....	13
Signalink USB .....	14
USInterface Navigator .....	14
Radio Control .....	16
PTT .....	17
COM Port .....	18
Ham Radio Deluxe .....	18
Soundcard / VOX .....	18
<b>Your First QSO .....</b>	<b>19</b>
QSO Window .....	19
More Detail .....	20
Mode .....	20
Transmitting .....	21
Test Transmission .....	21
Using Macros .....	21
Add Log Entry .....	22
Add .....	24
More .....	25
My Station .....	26
<b>Advanced QSO Options .....</b>	<b>27</b>
Squelch .....	27
AFC .....	27
Signal Quality .....	27
Multi-Channel Support .....	27
TX Lock / Split Mode .....	28
Repeats .....	28
Waterfall .....	28
Main Toolbar .....	29
Favourites Toolbar .....	31
Modes Toolbar .....	31
Markers .....	31
Appearance .....	31
Options .....	33

<b>QSO Modes .....</b>	<b>35</b>
Wikipedia .....	35
PSK.....	35
CW.....	35
Filter .....	36
9->N .....	36
Signal Analysis.....	36
Options .....	36
Winkeyer .....	36
Hellschreiber.....	36
Bandwidth .....	37
Screenshot .....	37
Browse.....	37
Erase.....	37
Feld-Hell Club.....	37
Options .....	37
MFSK .....	39
MT63.....	39
Olivia.....	40
RTTY.....	40
Reverse .....	40
Defaults .....	40
UoS (Unshift On Space).....	40
LtoF.....	40
Throb .....	40
<b>SSTV.....</b>	<b>41</b>
Quick Start.....	41
First Steps .....	41
Dedicated Soundcard.....	41
Soundcard Calibration.....	42
Receiving Images .....	43
Signal Detection .....	43
Transmitting .....	44
More Options.....	44
Template Editor.....	45
Default.....	45
Background .....	45
Adding Text .....	45
Saving.....	47
FTP.....	48
Image Window .....	49
Receive Window .....	49
Transmit Window.....	49
Webcam.....	49
<b>Callsign Lookup .....</b>	<b>51</b>
CD Lookups.....	51
QRZ.com .....	51
Subscriptions .....	51
Web Browser.....	51
Donations .....	52
<b>Logbook.....</b>	<b>53</b>
Quick Log.....	53
Main Logbook .....	54
Layout .....	55
ADIF .....	55
Cabrillo.....	58
Merge HRD .....	58
Google Earth .....	59

Options .....	59
Countries File .....	60
eQSL.cc .....	60
QSO Forwarding .....	60
Analysis .....	60
<b>SuperBrowser .....</b>	<b>61</b>
Options .....	62
Main Toolbar .....	62
Favourites Toolbar .....	63
Transfer To QSO Window .....	63
QSO Window .....	63
Options .....	63
Visual .....	64
Operation .....	64
PSK Propagation Reporter.....	65
<b>Web Browsers .....</b>	<b>67</b>
<b>World Map.....</b>	<b>69</b>
<b>Alarms .....</b>	<b>71</b>
Manager .....	71
Editor .....	72
Match Text .....	72
Testing Alarms .....	75
SuperBrowser Colours.....	75
Text-To-Speech .....	75
<b>Identities .....</b>	<b>77</b>
Options .....	78
<b>Logfile.....</b>	<b>79</b>
<b>Macros .....</b>	<b>81</b>
Manager .....	81
Editor .....	82
Definition .....	84
Radio Control .....	85
Video ID .....	87
Preview .....	87
<b>Program Options.....</b>	<b>89</b>
eQSL.cc .....	89
Themes And Skins.....	90
Storage.....	90
<b>Radio Interface.....</b>	<b>91</b>
Favourites .....	91
Manager.....	91
Editing.....	92
<b>Release Notes.....</b>	<b>93</b>
<b>Various .....</b>	<b>95</b>
Time Synchronisation.....	95
WWV Updates.....	96
<b>Index.....</b>	<b>97</b>



# Introduction

Digital Master (DM780) is a new program supporting the most commonly used digital modes, a replacement for PSK31 Deluxe. DM780 is closely integrated with Ham Radio Deluxe.

To see what is new look at the **Error! Reference source not found.** (page **Error! Bookmark not defined.**).

Q: What does 780 signify?

A: A tribute to one of the finest computers ever built, the VAX 11/780.



Q: Why write Digital Master 780?

A: Many reasons:

- Self-education,
- Encourage people to try the digital modes,
- Put something back into the hobby.

---

## Supported Modes

The first release supports the main digital modes as well as SSTV:

- PSK / QPSK,
- CW,
- DominoEx,
- Hellschreiber,
- MFSK,
- MT63,

- Olivia,
- RTTY,
- Throb.

The source for the digital mode DLL is available, if you can't find it on the Ham Radio Deluxe website just ask and I'll make sure it's available.

Copyright and credits is available from the Help menu in DM780.

In DM780 you find all the features you expect of a modern program such as an integrated logbook, world map and web browsers. The DM780 philosophy is to get the UI working properly before more modes are added.

A lot of the decoder code is taken from Fldigi, a fine digital mode program for Linux. For more information: <http://www.w1hkj.com/Fldigi.html> . The author of Fldigi, W1HKJ has kindly allowed me to use his code for these modes.

---

## Operating System Support

DM780 is designed for Windows 2000, XP and VISTA. Older versions of Windows such as Windows 98 are not supported.

There are *no* plans for Linux or Mac OS versions. The UI code cannot be made available; also it is not possible to port it to a UNIX-based operating system. If you want a UNIX / Linux solution either look at Fldigi (see above) or use WINE from <http://winehq.org/> .

### VISTA

VISTA introduces a new API for soundcard access, fortunately the older NT / XP API is still available. DM780 uses the older API for the time being.

---

## Hardware Requirement

Although one member of the test team has satisfactory results using a 500 MHz CPU and Windows XP a realistic minimum system would be a 1 GHz Intel CPU and 512 MB of RAM.

A high-end soundcard such as the M-Audio Delta 44 or Edirol FA-66 is not essential but recommended (I have had problems with my Delta-44 on VISTA). Currently I am using a TS-480SAT with an Edirol FA-66 and VISTA-32 – a great combination.

Please consider the excellent Navigator from <http://usinterface.com/> .

If you are using a laptop be aware that the internal soundcard may be very poor indeed, consider the Signalink USB from Tigertronics <http://www.tigertronics.com/>.



---

## Meet The Users

The HRD and DM780 support forums are found at <http://forums.ham-radio.ch/> .

The homepage is <http://www.ham-radio-deluxe.com/> .

You do not need to register to view the forums!



# Getting Started

Follow these steps to configure DM780 and enjoy your first digital mode QSO.

---

## Audio Interfacing

You need an audio interface to connect your rig's audio in/out to the computer's soundcard. This eliminates troublesome ground loops and prevents hum and noise from degrading the signals.

Audio interfacing can be done in so many ways that it would take days to plough through all the available information. It is possible to connect your radio directly to your soundcard without any form of isolating interface but this is not recommended.

### Commercial Solutions

From England there are the ZLP Electronics DigiMaster interfaces, inexpensive, *very well made* and used with my TS-480SAT.



From Oregon USA, Tigertronics manufactures the Signalink interfaces, used with my IC-703 and FT-817.



From Maryland USA the Navigator from USInterface.com is an excellent solution.



From Connecticut USA, West Mountain Radio provides the RIGBlaster solutions.



## DIY

Here is a circuit recommended by Peter PH1PH (SK), this text was written by Peter in 2004.

"Here is a circuit that has proved its worth many times. It will work with any ICOM or Yaesu rig that has a 6-pin mini-DIN connector for external audio. It will of course work on just about any other rig that exists, but you will have to make changes to the connections to your radio. Please check the actual connections to the mini-DIN - I can accept no responsibility for damage to your rig should things go wrong. I have to say that the one that I built to this circuit worked perfectly well on my FT-817 and IC-703 without changes..."

"You should always use the rig's high-impedance audio output if there is one available: this supplies a constant signal level to the soundcard. Most rigs also have a TX audio connector independent to the microphone input: you are advised to use this input. Some commercial interfaces don't allow this: my recommendation is to avoid any interface requiring use of the microphone connector and speaker output unless there is no other option for getting signals in

and out of the radio."

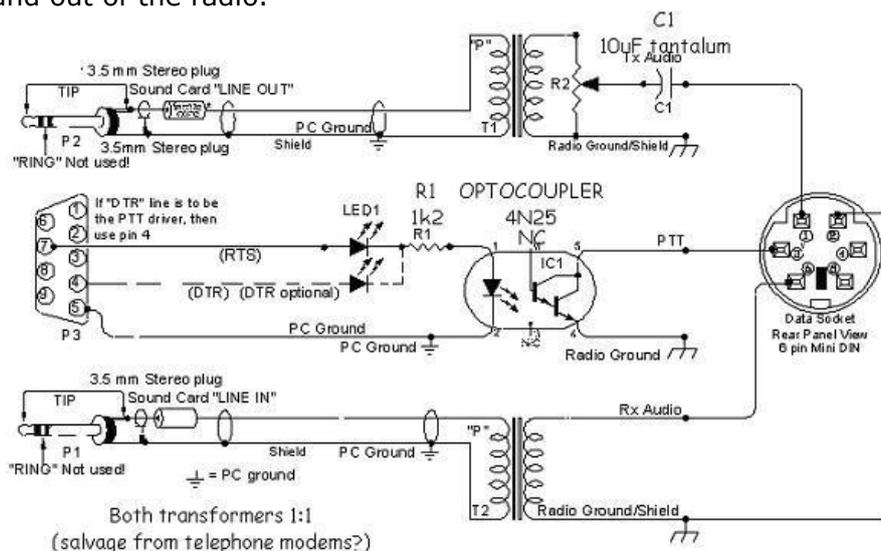

## Tags

Enter values in the Tags window; these values are used in macros (shortcuts which save you entering the same text every time you have a QSO). The values are saved automatically.



If you want more tags select the *QSO:General* page of the *Program Options* and enable the option:

*Show multiple sets of tags (displays the Tags toolbar)*

## Soundcard

Select your soundcard as follows:

Either:

- From the *View* menu select *Soundcard*,
- In the Soundcard pane press the *Options* button.

Or:

- Press *F8* to display the *Program Options* (or select *Program Options* from the *Tools* menu),
- Select the *Soundcard* page.

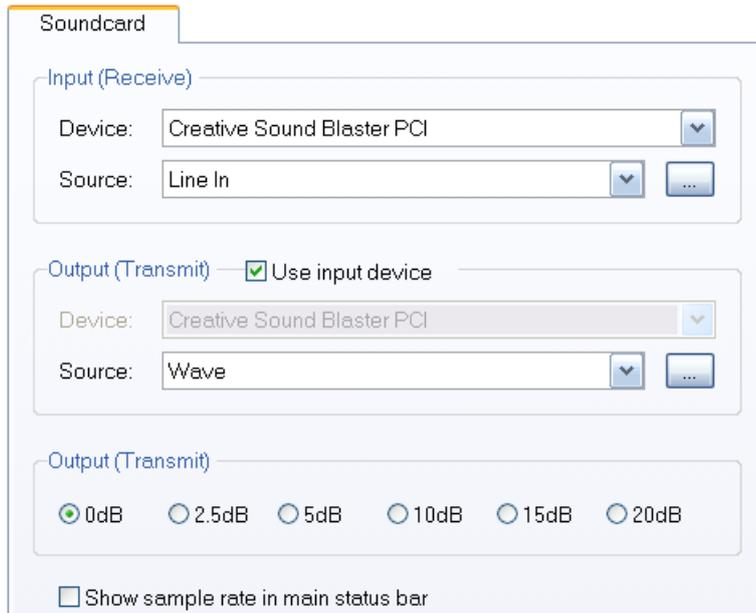

A good soundcard is recommended; some PC's come with very poor solutions built onto the motherboard (this is especially true for laptops). You can use the PC's default soundcard to get going, but the difference between a poor soundcard and a card such as the M-Audio Delta 44 or a Creative Audigy is like night and day. *You will be able to decode signals much better with a good soundcard.*

## SignalLink USB

Tigertronics make a great external soundcard that you connect to a USB port on your computer; this is the SignalLink USB, which also provides an audio interface between the radio and PC to isolate your computer from your radio.

Available direct from [Tigertronics](#) and [Martin Lynch & Sons \(UK\)](#).



An advantage of a second soundcard is you can use the internal card for normal Windows sounds and the DM780 alarms.

## USInterface Navigator

- Just ONE USB cable to your computer controls EVERYTHING using ANY software.
- Everything is built into the Navigator including a high speed sound card and monitor.
- K1EL's newest Software Defined WinKey USB Keyer v21 is also built in.

- The Navigator has the lowest noise level on the market... bar none. Quit losing those weak signals and start working stations you couldn't copy before.
- MARS ALE users: The Navigator Interface meets Microsoft standards for an audio codec device. TRUE sampling rates can easily be set as high as 48 KHz.
- You can plug TWO (or more) Navigator Interfaces into the SAME computer while they each operate SEPARATE transceivers! No other interface can accomplish that.
- The case is 100% extruded aluminum. (No thin bent aluminum or metal here.) It's so robust you could put four more 706's on top.
- Laser engraved, milled and drilled front and rear panels. (No paint or decals.)



### Navigator Console

DM780 has a special window for managing the Navigator. Operation should be obvious, below is the output from a Windows VISTA system.

For full information select the Help tab and read on...

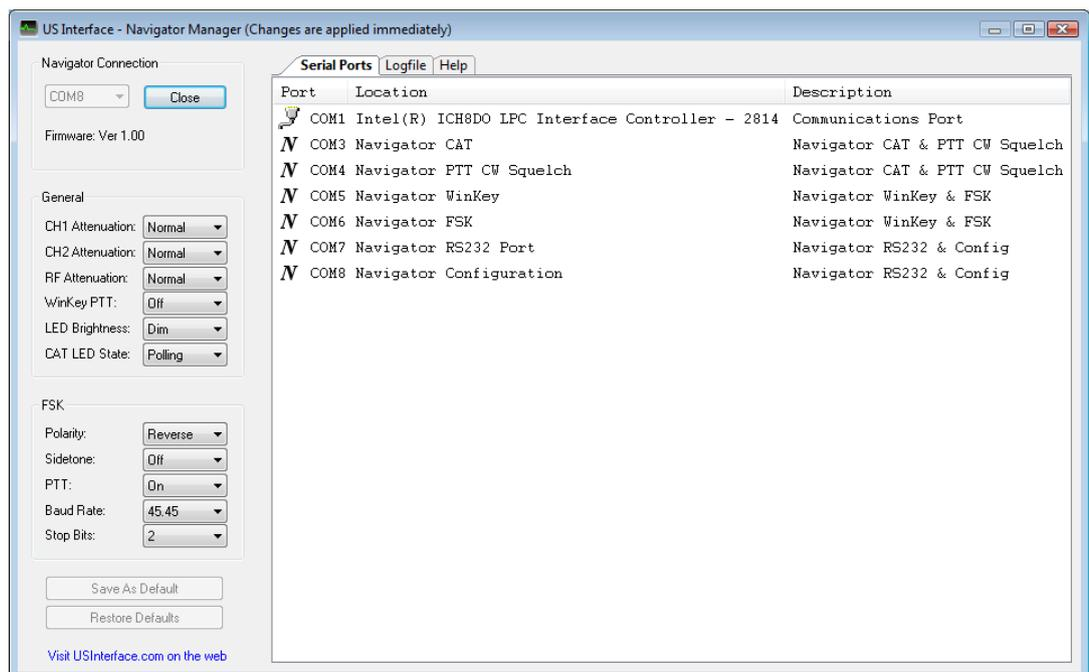

---

## Radio Control

DM780 uses Ham Radio Deluxe (HRD) for radio control. To set up a connection between DM780 and HRD:

- In DM780 open the Radio display (select *Radio* from the *View* menu),
- Press  Configure (the right-most button on the toolbar),
- Read the help text, this contains everything you need to know!



To configure the radio interface:

- Make sure Ham Radio Deluxe (HRD) is started and connected to a radio, you must use build 1317 or later.
- In HRD select IP Server from the Tools menu, make sure the IP Server is started and is configured to start when HRD starts.

The IP Server window also shows the addresses assigned to your computer. If connecting from another computer in your network you usually select the first address.



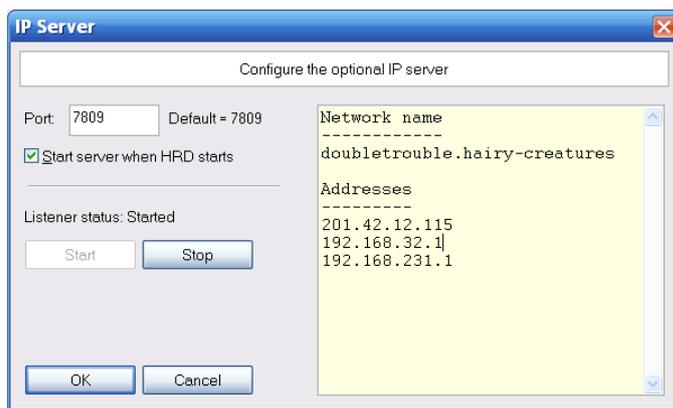

- In DM780 select *Radio* from the *View* menu, in the *Radio* pane press the *Configure* button.

In the *Configure Radio Pane* window:

- HRD address - the address or name of the computer where HRD is running, localhost (or 127.0.0.1) if the local computer.
- HRD port - the default port is 7809.
- Press *Connect* to HRD.

If a connection can be established:

- All buttons are enabled,
- The *Dropdown* buttons are automatically loaded with the dropdown buttons shown the HRD's display,
- The **TX** push button is automatically loaded (if available for your radio).
- TS-480SAT - the **TX Alt** button is used for PTT via the rear connector.

To change a selection click on a button, then select an entry from the popup window. To clear the current selection, select the first entry '- - -'.

When you have finished defining your layout press *Save*. The definitions are saved in your local storage folder (from the *Tools* menu select *Program Options*, then select the *Storage* pane). For example, the IC-703 definitions are stored in `DMRadioLayout_IC-703.xml` .

In the *Radio* pane press the *Connect* button  to connect to HRD.

---

## PTT

Normally you use HRD for PTT control, PTT is configured on the PTT pane of the *Program Options* (page 89).



## COM Port

To use a COM port for PTT:

- Select [X] via Serial (COM) port...
- Select the COM port; this must not be in use by another program,
- Select DTR, RTS or DTR and RTS.

When you switch to TX DTR and/or RTS are set (raised), when you return to RX they are cleared.

## Ham Radio Deluxe

To use HRD the radio pane must be connected to HRD:

- In the *View* menu select *Radio*
- In the Radio pane press *Configure* and read the instructions!

## Soundcard / VOX

If you are using a soundcard such as the SignalLink USB you can let the soundcard control the PTT or you can use the PTT built into your radio.

# Your First QSO

If a QSO window is not displayed just press the QSO button. A typical QSO window layout is shown below.

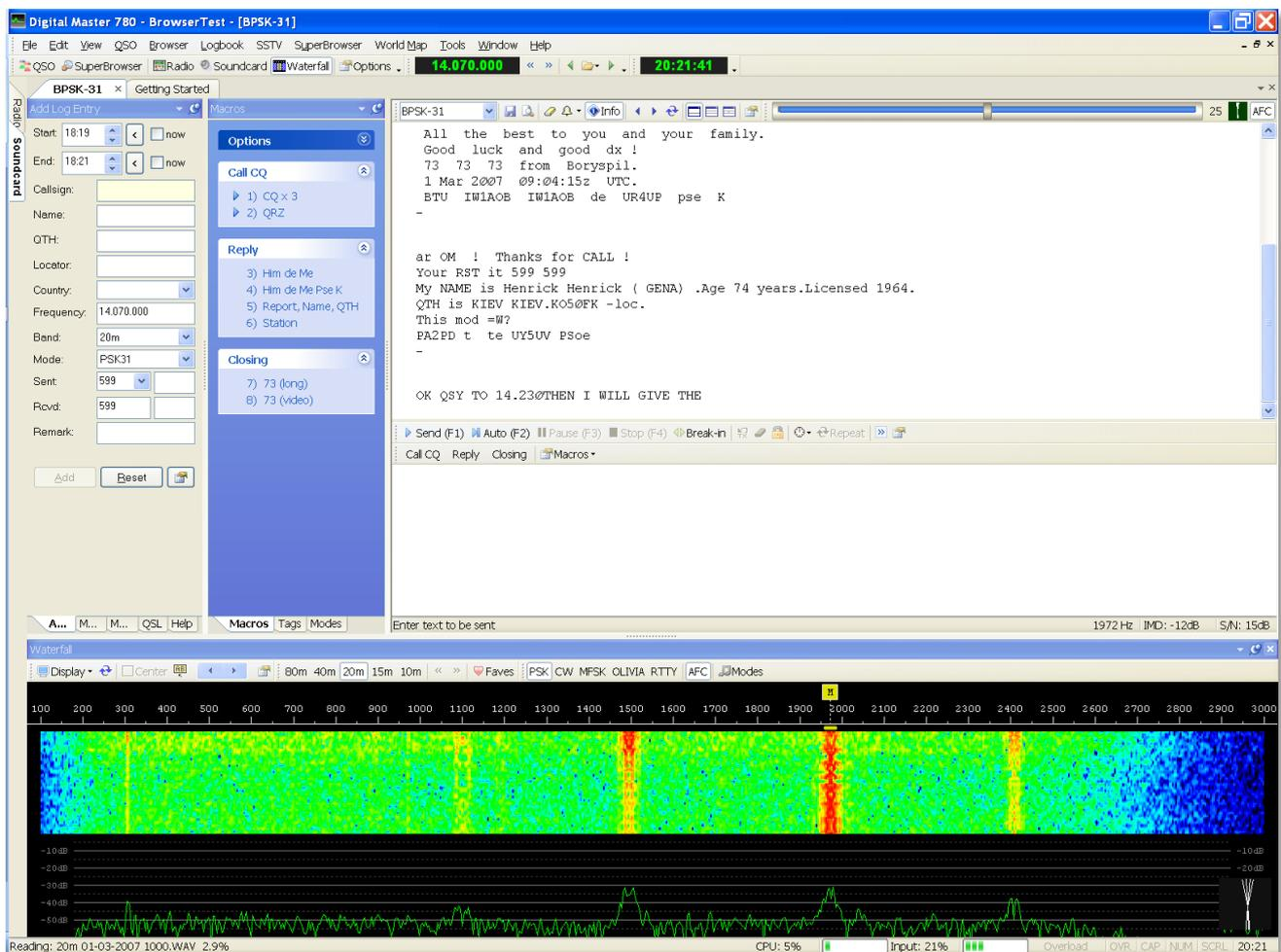

## QSO Window

The major components of the QSO window are:

- Logbook (Add Log Entry) add an entry to DM780's logbook. Click on the tabs to select the pages.

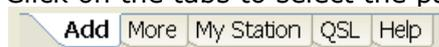

- Macros, Tags, Modes:
  - Macros – pre-defined text that you use when composing the text you want to send.
  - Tags – information about yourself and your station, which is organized into fields, which in turn are used by macro definitions.
  - Modes – add modes currently supported by DM780.
- Receive window – decoded text is displayed here.

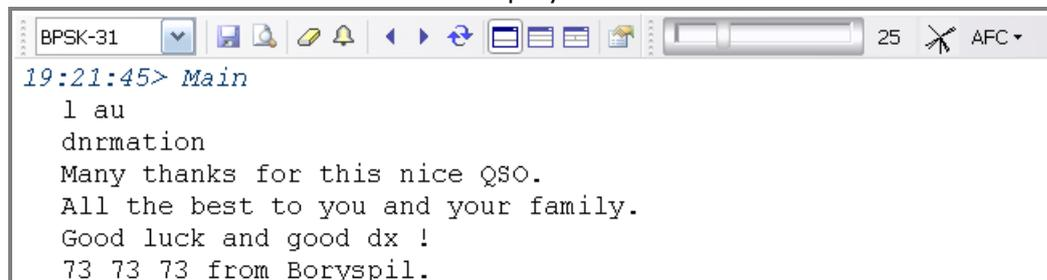

- Transmit window – the text you send is composed here.



- Waterfall - at the bottom you see the Waterfall, the red stripes are PSK31 signals. To select a signal, just click on the stripe.

## More Detail

If the Waterfall is not displaying signals, check:

- Your radio is switched on,
- The correct soundcard is selected,
- The correct input source is selected and enabled,
- The cables are correctly connected to your radio and soundcard interface.

## Mode

Select the correct mode. The default is PSK31, used in 95% or more PSK QSO's. Select the mode with either:

- The dropdown option in the receive window, or
- The Modes pane.

## Transmitting

Before you make your first test transmission you must decide how you will switch your radio between transmit and receive.

The options are:

- PTT using a serial (COM) port,
- PTT via Ham Radio Deluxe,
- VOX (depends on your radio and soundcard interface).

To select PTT open the PTT page of the Program Options (selected from the Tools menu).

## Test Transmission

---

It is very important that you transmit a clean, linear signal. Never, ever use any compression or ALC.

---

To transmit just press either:

- Send (F1) – starts sending, when all text has been sent press Stop (F4).
- Auto (F2) – starts sending, stops when all text has been sent.

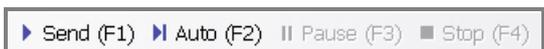

When you start sending you will see the classic PSK 'tramlines' in the waterfall window:

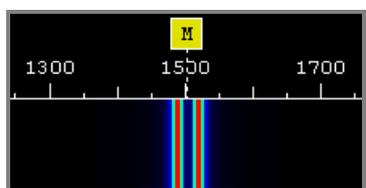

When text is being sent the signal looks like this:

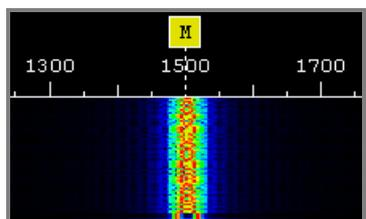

If you have configured your radio interface correctly your radio will switch to transmit mode when you start sending.

---

To stop sending immediately, just press *Escape* on your keyboard.

---

## Using Macros

To select a macro either:

- Select an entry from the Macros pane, or

- Click an entry in the Macros bar.

The macros bar is usually the most convenient option. In the picture below the macros bar is the second strip of buttons.



In this example the text that has been sent is displayed with a blue strikethrough font.

---

To directly edit a macro right-click on the button in the macros bar.

---

## Add Log Entry

Although you can type values into the fields in the Add Log Entry window, a faster option is to double-click on text in the receive window and select options from the popup menu.

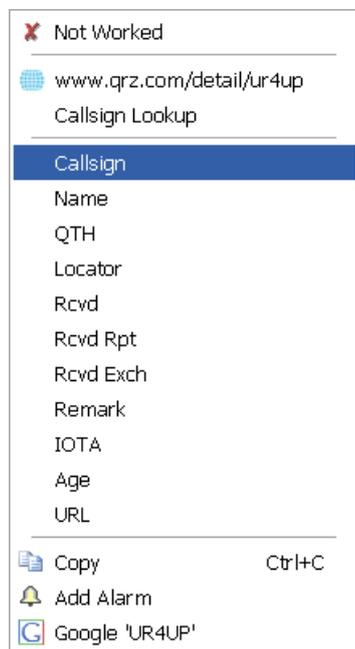

In this example the text UR4UP has been selected.

(Because UR4UP is an alphanumeric string and possibly a valid callsign, the entries in the popup window include the callsign lookup / QRZ options.)

To copy UR4UP into the Callsign field in the Add Log Entry window just select *Callsign* from the popup menu.

---

Hint: if you press Shift while double-clicking the selected text is copied into the Callsign field without displaying the popup menu.

---

The entries in the menu are:

- Worked status,
- Lookup using QRZ.com or DM780's Callsign Lookup window,
- The Add Log Entry fields – the main fields are supported,
- Copy to clipboard,
- Add Alarm – create an alarm from the callsign,

- Google for the callsign.

## Add

The screenshot shows the 'Add Log Entry' dialog box with the following fields and values:

- Start: 07:46 (with 'now' checkbox)
- End: 07:46 (with 'now' checkbox)
- Callsign: GD4ELI (checked)
- Name: Simon Brown
- QTH: Ramsey,
- Locator: IO74th
- Country: Isle of Man
- Frequency: 0
- Band: 40m
- Mode: PSK31
- Sent: 599
- Rcvd: 599
- Remark: (empty)

Buttons: Add, Reset, [Help Icon]

Worked: 60m, 80m

Footer: Add More My... QSL Help

This page contains the most commonly used fields.

### Start and End Times

The times are usually shown using UTC, use the Program Options / Logbook pane to select either UTC or Local time. The time is always stored in the logbook using UTC.

### Start

The start time for the QSO. If you check *[\_] Now* the start time is updated with the current time.

In the Program Options / Logbook pane optionally select:

*Update when adding callsign* - the time is updated when you add a new value in the Callsign field if previously empty,

*Update when adding logbook entry.*

### End

The end time of the QSO. If you check *[\_] Now* the end time is updated with the current time. In the Program Options

/ Logbook pane optionally select:

*Update when adding logbook entry.*

### Callsign

The station contacted. When you enter the callsign the *Country* is updated automatically. This field is mandatory.

### Name

The operator's name, free-format text.

### QTH

The operator's location, free-format text.

### Locator

The Maidenhead locator, usually 6 characters, for example JN46pt.

### Country

Updated automatically when you enter a callsign, the list shown corresponds to the latest DXCC list of countries.

### Frequency

The current frequency, updated automatically from the Radio pane.

### Band

The current band, determined from the frequency.

### Mode

The current mode - the list contains the ADIF modes that are used for logbook import / export, awards, etc.

### Sent

Sent has two fields: *Report* (example - 599) and *Exchange* (for contests).



**Report**

The standard, select from the dropdown or entered via the keyboard.

**Exchange**

To enable auto-incremented values in the Exchange field enclose the numeric value to be incremented inside square brackets. For example, if you enter [001] then the value added to the logbook and inserted in macros is 001 and this value is incremented to 002 when you press *Add*. The square brackets are ignored.

**Remark**

A free-format text field.

**More**

This page contains less frequently used fields.

The screenshot shows the 'Add Log Entry' dialog box with the following fields and values:

- Continent: EU (dropdown)
- IOTA: EU (dropdown) 666 (text)
- CQ zone: 14 (text)
- ITU zone: 27 (text)
- County: Lezayre (text)
- State/prov: (empty text)
- ARRL sect: (dropdown)
- Address: Riverside, Glen Aulc (text)
- Age: 84 (text)
- URL: http://www.hb9drv.ch (text)
- Contest: Spaniel roundup (text)
- Flux/A/K: 68 (text) 7 (text) 3 (text)

At the bottom of the dialog are buttons: Add, Mo..., My ..., QSL, Help.

**Continent**

Select from the dropdown list.

**IOTA**

Islands On The Air reference – the IOTA homepage is: <http://www.rsgbiota.org/> .

**Contest**

If the contact is made during a contest, enter the name of the contest here.

**A index, K index, Solar flux**

The current space weather information available from NOAA via WWV.

## My Station

This page contains information about your station. As you may have many configurations up to ten different station profiles are supported.

After you have entered values press *Save*.

Use the *Copy To* option to save the current values to a different profile.

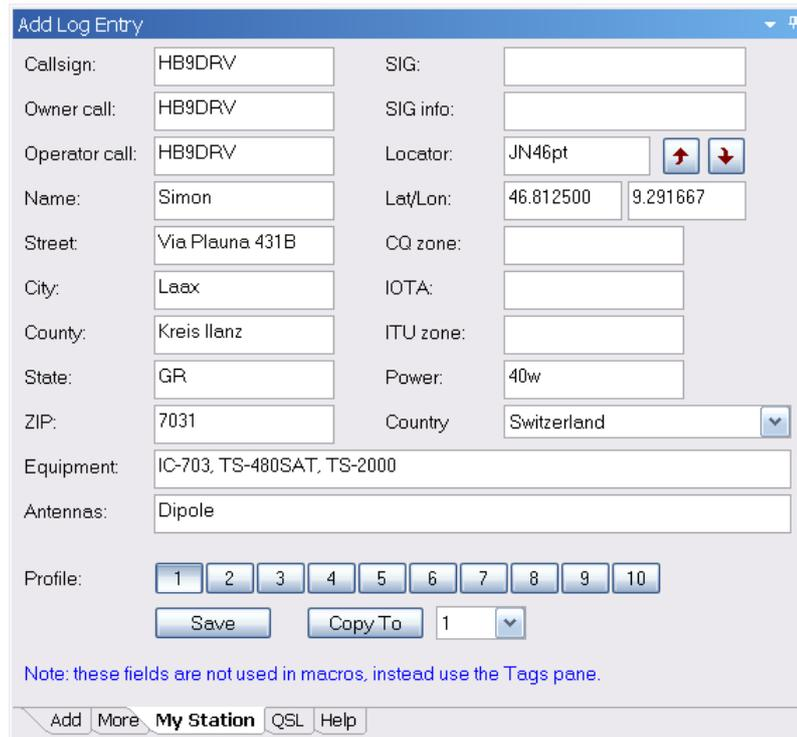

The screenshot shows a software window titled "Add Log Entry" with a light blue header and a grey background. The window contains a grid of input fields for station information. The fields are arranged in two columns. The left column includes: Callsign (HB9DRV), Owner call (HB9DRV), Operator call (HB9DRV), Name (Simon), Street (Via Plauna 431B), City (Laax), County (Kreis Ilanz), State (GR), ZIP (7031), Equipment (IC-703, TS-480SAT, TS-2000), and Antennas (Dipole). The right column includes: SIG (empty), SIG info (empty), Locator (JN46pt with up/down arrows), Lat/Lon (46.812500 and 9.291667), CQ zone (empty), IOTA (empty), ITU zone (empty), Power (40w), and Country (Switzerland dropdown). Below the grid are buttons for "Save" and "Copy To", followed by a profile selector with buttons 1-10 and a dropdown menu. A note at the bottom states: "Note: these fields are not used in macros, instead use the Tags pane." The window has a standard OS-style title bar and a menu bar with "Add", "More", "My Station", "QSL", and "Help".

Callsign:	HB9DRV	SIG:	
Owner call:	HB9DRV	SIG info:	
Operator call:	HB9DRV	Locator:	JN46pt
Name:	Simon	Lat/Lon:	46.812500 9.291667
Street:	Via Plauna 431B	CQ zone:	
City:	Laax	IOTA:	
County:	Kreis Ilanz	ITU zone:	
State:	GR	Power:	40w
ZIP:	7031	Country:	Switzerland
Equipment:	IC-703, TS-480SAT, TS-2000		
Antennas:	Dipole		

Profile: 1 2 3 4 5 6 7 8 9 10

Save Copy To 1

Note: these fields are not used in macros, instead use the Tags pane.

Add More My Station QSL Help

# Advanced QSO Options

---

## Squelch

The Squelch control operates in a similar way to the squelch on your FM receiver; the signal is only decoded when the strength is equal to or greater than the squelch setting.



In the above example the squelch threshold is set to 25 (the available range is 0 to 100), the actual signal level is significantly higher.

---

## AFC

Automatic Frequency Control ensures that you track a signal which may be drifting, also that your receive frequency is in the center of the signal.

---

## Signal Quality

The quality of the received signal is shown in the vector data display.

-  Vertical lines like this indicate a good PSK signal.
-  Random lines like this indicate a bad PSK signal.

---

## Multi-Channel Support

The standard QSO window supports 1, 2 or 3 receive channels.

-  One channel (Main).
-  Two channels, Main and Sub-A.
-  Three channels, Main, Sub-A and Sub-B.

You can only transmit using the Main channel, Sub-A and Sub-B are receive only.

Use the  button to swap the contents of Sub-A or Sub-B with the Main channel.

An alternative to multi-channels is the SuperBrowser.

---

## TX Lock / Split Mode

To enable split mode operation just press the TX lock button . Instead the main channel marker  is replaced with a transmit  and receive  marker.

To change either frequency click on the marker, then drag over a signal trace.

---

## Repeats

To send text at a regular interval use the repeat option. Typically you use this option to send a CQ text on a normally quiet band such as 50 MHz.

There are two buttons associated with repeats:

-  Select the repeat interval.
-  Repeat Enable repeats.

When a repeat interval is selected a progress bar is displayed at the bottom of the transmit window (on the window's status bar).

For example, with an 8 second interval:  

---

## Waterfall

The waterfall is your tuning dial; you select the signal to decode and if in split mode your transmit frequency.

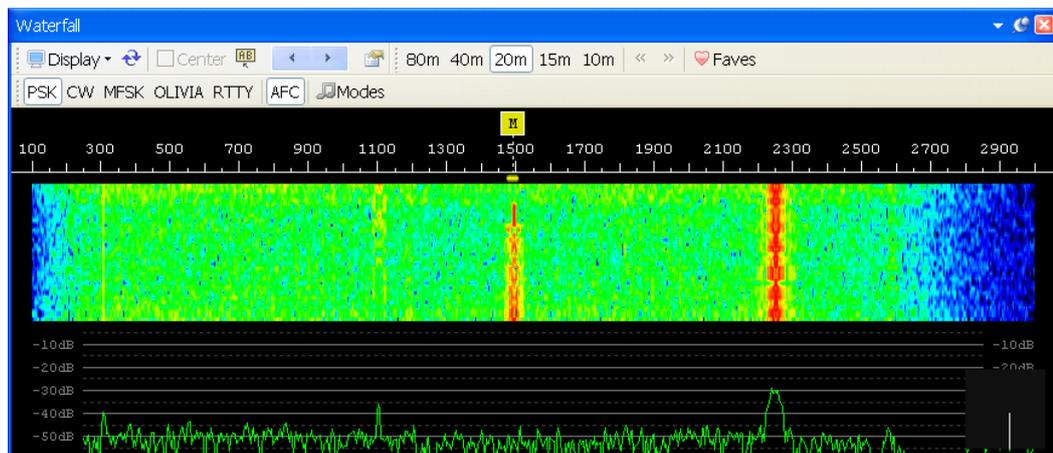

The waterfall display consists of:

- Main toolbar,



- Favourites toolbar,



- Modes toolbar,



- Markers,



- Frequency,



- Signal traces.

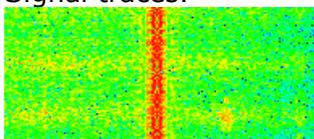

---

Toggle the toolbar visibility by right-clicking in the waterfall and selecting *Show Toolbars* from the popup menu.

---

## Main Toolbar

Note: as of 4.0 SP2 some of these options are found in the *Display* mode dropdown to avoid clutter.

The main toolbar options are:

-  Display mode – various algorithms to pull the signal trace out of the background noise. This does not affect the signal decoding.  shows the frequency spectrum.
- R** Show radio frequency (frequency of radio + audio offset).
-  Rewind the display – replays the stored audio.
-  Maximise the contrast (this does not affect the signal decoding).
-  Enable decoder popups – the trace under the cursor is decoded, the result displayed in a small popup window.

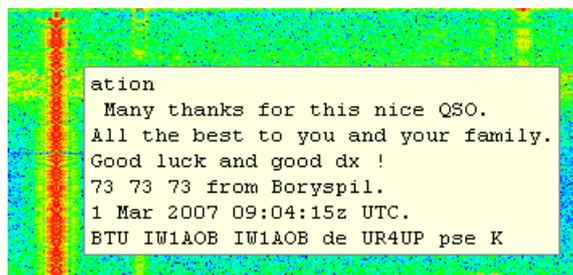

 Waterfall options.

### *Center Frequency*

If you have a radio with a narrow filter you use this option to position the selected signal in the center of your filter.

In the main toolbar there are three buttons associated with this option:

- Center Enables center frequency operation.
-  Click to apply center frequency.
-  Click to undo the last change.

When enabled, the  marker is displayed in the waterfall. Click and drag this to the center of your narrow filter.

To move the selected signal to the center frequency, click the  button on the toolbar or double-click the  marker in the waterfall.

## Favourites Toolbar

The favourites toolbar contains the frequencies you commonly use, it is provided to make switching between these frequencies as painless as possible.

	A favourite frequency (not selected).
	The currently selected favourite frequency.
	Adjust frequency by +/- 500Hz or +/- 2kHz.
	Start the favourites manager.

## Modes Toolbar

The modes toolbar contains the modes you commonly use.

	A favourite mode (not selected).
	The currently selected mode.
	Start the modes manager.

## Markers

The various markers you will see in the waterfall are shown below. To change a frequency click on, then drag the marker over a signal and release.

---

You must drag over the waterfall area where the signal traces are displayed, the cursor indicates the marker you are dragging.

---

To change the main channel frequency just click in the waterfall.

	A current Main channel frequency. Split mode  must be off.
	The current channel Sub-A (VFO-A) frequency.
	The current channel Sub-B (VFO-B) frequency.
	The receive (RX) frequency if split mode is enabled.
	The transmit (TX) frequency if split mode is enabled.
	Center frequency – see Center Frequency on page 30.

## Appearance

The waterfall appearance is configured with the Waterfall:1 and Waterfall:2 pages of the Program Options (selected from the Tools menu).

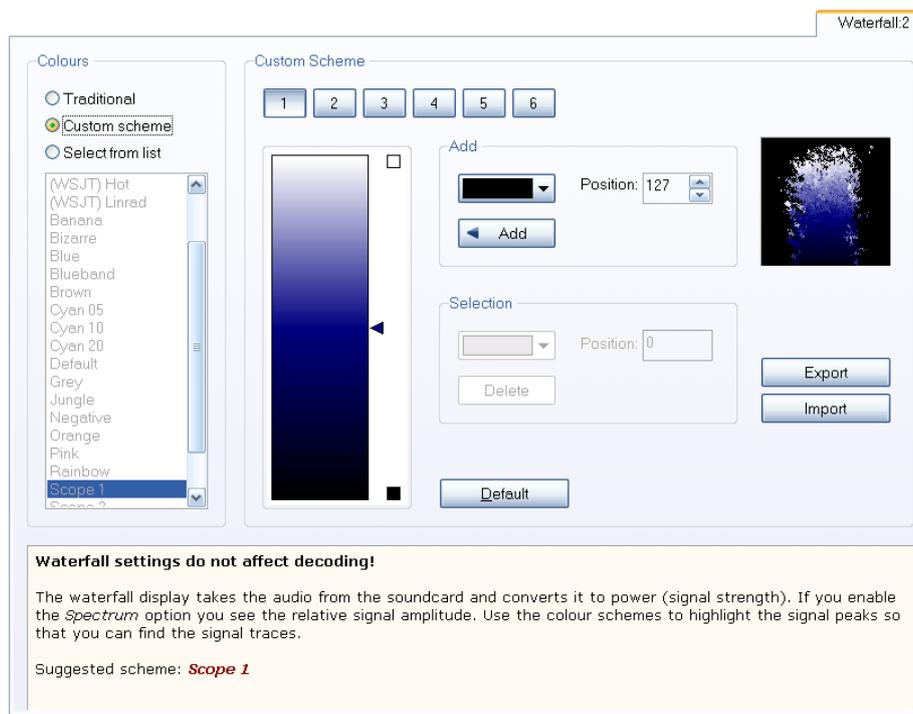
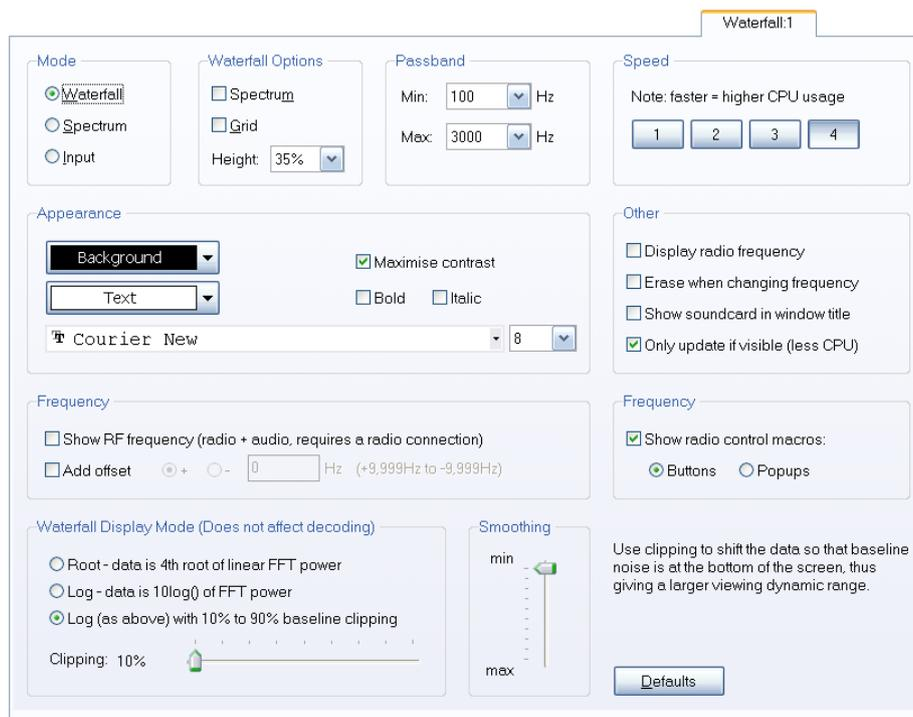

The most commonly used options are *Colour File* and the *Display Mode* settings.

Select the colour file that is best for you, (I prefer *Scope 1*).

The display mode settings adjust the data to make the signal traces more prominent; this has no effect on the decoding. The default setting is shown in the above screenshot.



---

## Options

There are three panes in the Program Options (page 89) used by the QSO window:

- QSO:General,
- QSO:Receive and
- QSO:Transmit.

Familiarise yourself with the options on these panes.



# QSO Modes

When you select a new mode the options specific to that mode are displayed on an extra toolbar. This section explains the options for these modes.

---

## Wikipedia

This is an excellent resource with a good description of digital modes.

---

## PSK

<http://en.wikipedia.org/wiki/PSK31>

PSK is the most commonly used mode, there are no special options. 95% of traffic uses PSK-31, the rest using mainly PSK-63. QPSK (a variant of PSK) is rarely used.

---

## CW

[http://en.wikipedia.org/wiki/Continuous\\_wave](http://en.wikipedia.org/wiki/Continuous_wave)

CW is supported in four variants:

- Standard CW where the radio is keyed via a serial or parallel port,
- Modulated CW (MCW) where the tones are generated by the soundcard,
- Using the KY command with Elecraft, Kenwood and Flex-Radio radios (read the PTT information below),
- Using the K1EL Winkeyer.

All support the CW decoder.

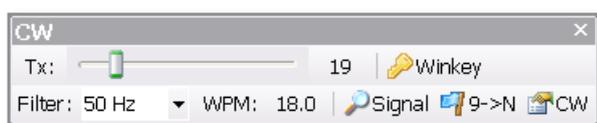

## Filter

The width of the software filter used to decode the incoming signal.

## 9->N

When checked sends N instead of 9 in reports copied from the Sent field of the ALE (add Log Entry) window.

## Signal Analysis

This window is designed to assist the development of the CW decoder.

## Options

The Mode:CW page of the Program Options is used to:

- select the serial / parallel port used for keying your radio,
- enable PTT,
- control the waveform.

See the help text on the Mode:CW page for more information.

## Winkeyer

DM780 supports all Winkeyer options with the exception of memory programming available with v2.0 and higher.

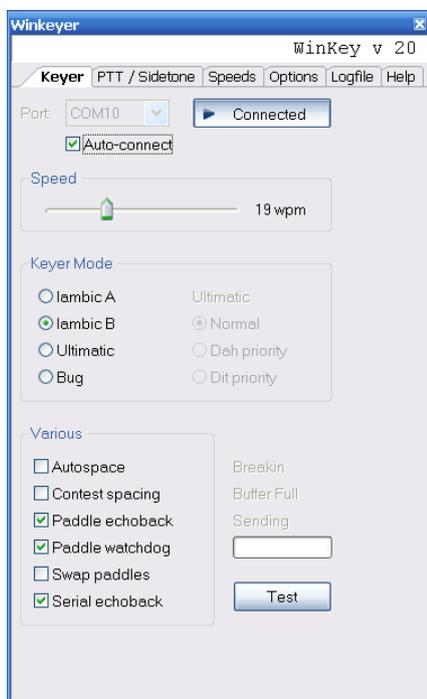

Check Auto-connect if you want to automatically connect when the CW (*WinKey*) mode is selected.

Press *Test* to send the text TEST DE DM780.

### Prosign Key Assignments

"	RR	/	DN
\$	SX	:	KN
'	WG	;	AA
(	KN	<	AR
)	KK	=	BT
+	AR	>	SK
-	DU	@	AC

---

## Hellschreiber

<http://en.wikipedia.org/wiki/Feld-Hell>

It is important to note that the output window is actually an image, not text so you cannot highlight any text!



## Bandwidth

The receiver bandwidth filter, the default is 245Hz which is usable in almost all situations.

## Screenshot

Takes a copy of the output window, displays this with the Windows default image viewer.

## Browse

Browse the default pictures folder for screenshots.

## Erase

Erases the output window.

## Feld-Hell Club

A link to the main Hellscreiber club, <http://feldhellclub.org/index.php>.

## Options

The other options are:

### Font

Select the transmission font from the list built into DM780.

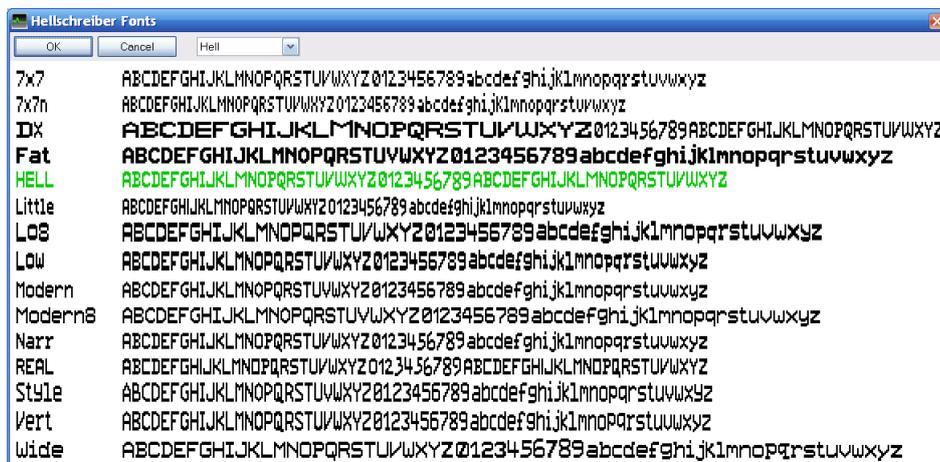

### DX Mode

Transmits wider characters, for example using the Hell font with HB9DRV transmitted normally then in DX mode:



### Hard Keying

When enabled transmits with a faster rise time (more 'clicky'), the default is soft keying. The explanation below is from Dave Freese W1HKJ whose code is used in DM780.

*The hard keying option will give sharper edges to some fonts at the expense of additional transmitted bandwidth. It was added to the fldigi Hell modem code at the request of several VHF Hell operators. Both keying wave shapes are raised cosine; soft keying (the normal has a rise time of 4 msec and hard keying a rise time of 2 msec. The rise time is the time it takes the raised cosine wave shape to reach 100% of the transmit signal level. Since the normal Feld-Hell dot pulse width is  $1 / (2 \times 14 \times 17.5)$  or 8.163 msec the 4 msec raised cosine pulse looks very symmetrical with the pulse peak at the center of the pulse.*

*The 2 msec rise time nearly doubles the average power in a dot interval. Feld-Hell requires a linear transmitter just like Psk. In the pulse with a 4 msec rise time the average power of a dot is 0.375 times the peak power. In the pulse with a 2 msec rise time that increases to 0.687 times the peak power. This can help to darken the received pixels that are only a single dot in transmission width.*

So, bottom line is:

- Use soft keying (4 msec rise time) when s/n is good and the band contains other amateur signals. Be a good neighbor. On VHF or UHF you could just use 2 msec assuming a clear band.
- If s/n is bad and/or the band is empty try using the hard keying (2 msec rise time) to give a sharper and darker video at the receive end.

### Uppercase

Transmits all text in uppercase.

### Blackboard

Black background, white text, for example receiving HB9DRV normally then with Blackboard on:



### Halfwidth

Displays half-width characters, rarely used.



### Small

Reduces the size of the displayed image by 50%. The first example is normal size, the second small.

```

...WRITING SOFTWARE IS GREAT FUN...
...WRITING SOFTWARE IS GREAT FUN...
...WRITING SOFTWARE IS GREAT FUN...
...WRITING SOFTWARE IS GREAT FUN...
...WRITING SOFTWARE IS GREAT FUN...
...WRITING SOFTWARE IS GREAT FUN...
...WRITING SOFTWARE IS GREAT FUN...
...WRITING SOFTWARE IS GREAT FUN...
...WRITING SOFTWARE IS GREAT FUN...
...WRITING SOFTWARE IS GREAT FUN...

```

## MFSK

[http://en.wikipedia.org/wiki/Multiple\\_frequency-shift\\_keying](http://en.wikipedia.org/wiki/Multiple_frequency-shift_keying)

The only options are *Reverse* and exclusive to MFSK 16 there is a picture option.

### TX Picture

The picture size is restricted to 320 x 256 as suggested by Patrick F6CTE in MultiPSK.

Pictures are either colour or greyscale, greyscale being transmitted three times faster than colour.



In this example the 320 x 213 pixel picture of a young programmer and his dog takes 204.5 seconds to send (68,160 pixels).

To insert a picture enter the tag `<send-pic>` in the transmit window, for example 'Here is a picture of my dog `<send-pic>`'.

The picture is sent using the size shown in this window;

adjust the size by dragging the border of the window.

Smaller pictures are obviously sent faster.

## MT63

<http://en.wikipedia.org/wiki/MT63>

The only option is the interleave, normally this is set to *Long*.

*Note – for accurate reception of MT63 you must use an accurate soundcard. Most problems associated with MT63 are due to incorrectly calibrated soundcards.*

---

## Olivia

[http://en.wikipedia.org/wiki/Olivia\\_MFSK](http://en.wikipedia.org/wiki/Olivia_MFSK)



The Olivia options are above.

*Note – for accurate reception of MT63 you must use an accurate soundcard. Most problems associated with MT63 are due to incorrectly calibrated soundcards.*

---

## RTTY

<http://en.wikipedia.org/wiki/Radioteletype>

The default RTTY setting is 45.45 baud, 170Hz shift. In Europe RTTY is generally send using USB irrespective of the frequency.



### Reverse

In North America LSB is used on 7Mhz and below, hence the Reverse button.

### Defaults

Restores the default settings.

### UoS (Unshift On Space)

When this option is selected, received characters are switched from digits to letters after receiving a *Space* or *LineFeed* character.

### LtoF

When enabled the Letters to Figures popup window is displayed (5-bit RTTY only).

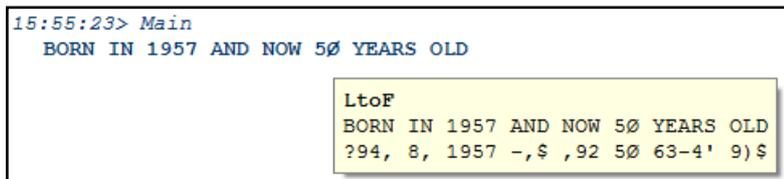

---

## Throb

There are no special Throb options.



# SSTV

On December 14<sup>th</sup>, 2007 the bug bit thanks to MM-SSTV written by Makoto Mori, JE3HHT. Version 4 of DM780 contains the most common SSTV modes:

- Martin 1 and 2 by Martin Emmerson,
- Scottie 1, 2 and DX by Eddie Murphy,
- P3, P5 and P7 (the Pasokon 'P' modes) by John Langner.

More modes such as Robot 26, Black and White and the PD modes will be added later.

SSTV is actually an analogue mode with an optional digital header (the VIS code which is sent before the image, identifying the transmission mode used) and FSK footer which contains the sender's callsign.

For an excellent introduction see the Wikipedia entry for SSTV: [http://en.wikipedia.org/wiki/Slow-scan\\_television](http://en.wikipedia.org/wiki/Slow-scan_television) .

---

## Quick Start

If you just want to watch the pretty pictures:

- Tune your radio to 14.230Mhz USB,
- Make sure your filter covers at least 1,000Hz to 2,400Hz,
- Wait!

---

## First Steps

### Dedicated Soundcard

For SSTV and all soundcard modes in general it is strongly recommended that you use a second soundcard. With SSTV one often sees images transmitted with interruptions due to the SSTV soundcard playing Windows sounds created while the operator plays with other Windows applications. A soundcard dedicated to digital modes and SSTV is the best solution.

## Soundcard Calibration

When using SSTV it is essential that you calibrate your soundcard and enter the calibrated values in the *SSTV Options* pane *Calibration*.

Press the *Options* button on the SSTV toolbar or select *Options* from the SSTV menu. Select the *Soundcard Calibration* tab. Click *Calibration* and read the help text.

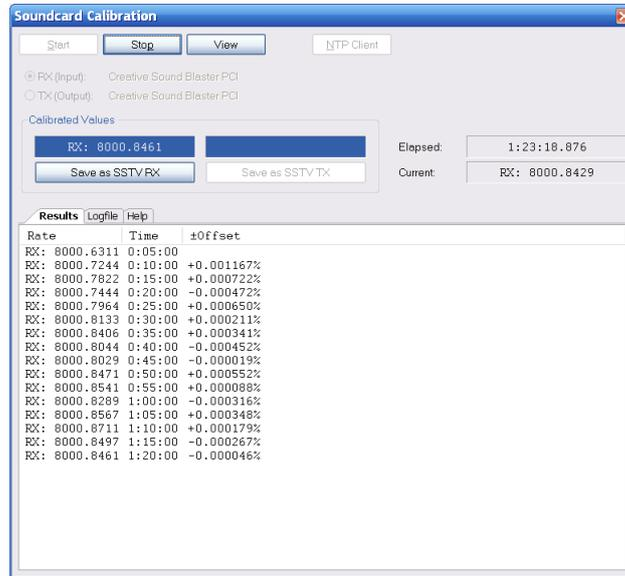

Receive Calibration

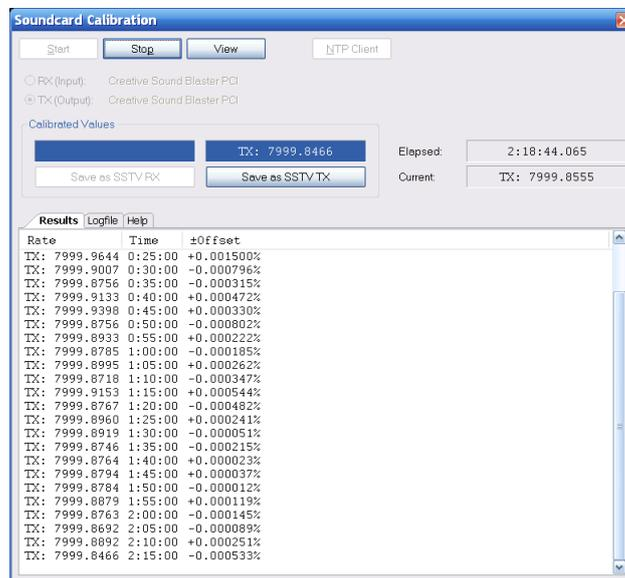

Transmit Calibration

The Soundcard Calibration window measures the soundcard data throughput using a NTP (Network Time Protocol) server as the time reference. (In a worst-case scenario you may need a few hours for very accurate calibration.) When the calibration is finished enter the values displayed in the *Soundcard Calibration* window.

In the above examples the Creative Sound Blaster PCI card has returned very stable values after only five minutes. A tenth of a Hertz (0.1) accuracy is enough. What is also interesting is that the transmit and receive values are not the same – but this is a very old 16-bit card! On my Edirol FA-66 there is no difference.

If you do not properly calibrate your soundcard then all received images will be displayed with a slant - although you can correct this yourself it becomes frustrating after a while. Also your transmitted images will be slanted – not what a good DM780 operator wants!

An alternate solution top using the NTP client is to adjust the slant on an image received from a station known for good calibration, for example VK6AAL. As you adjust the slant the sample rate used for decoding is shown in the slant window.

## Receiving Images

The fastest way to receive your first images is to tune your radio to 14.230 MHz USB, set your filter so that the passband is at least 1000Hz to 2400Hz and just wait for an image to be displayed. For example with my K3 I use the 1.8kHz filter from 800Hz to 2600Hz.

To adjust the incoming picture for slant either:

- make sure Auto-slant is checked, or
- use the // / | \ \ buttons, or
- drag the image - click on the received image with the left mouse button and drag left or right.



To adjust the horizontal offset use the << < | > >> buttons.



## Signal Detection

Select the *SSTV Options* tab *Detection*.

- VIS codes - a digital VIS (vertical interval signaling) code can be sent before the image, identifying the transmission mode used. All SSTV software supports this.
- Sync pulses - if the VIS code is not detected due to QRM, fading or some other reason then the fall back solution is to detect the transmission mode by measuring the interval between consecutive 1200Hz sync pulses. Given enough sync pulses it is possible to compute and correct any slant.

Normally you have both options enabled.

---

## Transmitting

You first create a set of templates with at least one template for each phase of a QSO:

- Calling CQ,
- Replying to a CQ call,
- Sending QSO information (name, location RSQ),
- Signing off (73).

To see your templates select *TX: Templates* in the lower tab bar. Click *New* to create a new template or select an existing template and click *Edit*. (See Template Editor on page 45 for more information.)

To load a template just double-click on the template.

When you press **▶TX** a wave file is created in memory with the data to be sent. Your radio is switched to transmit using the option selected in the *PTT* page of the *Program Options* (selected from the *Tools* menu).



In this example about 55% of the image has been sent.

### More Options

It is normal to:

1. prefix the image with a digital VIS (vertical interval signaling) code which identifies the transmission mode used, and
2. add your callsign in CW and FSK (frequency shift keying) after the image has been sent.

Sending the VIS code helps the other program detect the correct mode being used. If the VIS code cannot be detected or is missing then the only other solution is for the other program to attempt to detect the mode based on the sync pulses.

Sending in CW overcomes any legal requirements imposed on you by your licencing authorities, sending in FSK allows the other program to decode your callsign automatically and load it into the logbook.

In DM780 the VIS code is always sent, the CW and FSK identifications are enabled from the *SSTV Options* window (selected from the *SSTV* menu).

# Template Editor

Most SSTV formats are 320 x 256 pixels, DM780 allows you to create templates using double resolution 640 x 512.

## Default

A default template contains just a banner with:

- Locator
- Program Title
- Callsign

<Locator> Digital Master 780 <CALLSIGN>

## Background

To add a background image either:

- From the *Background* menu button *Select File* or
- Drag an image from Windows Explorer over the template.

Now decide whether the image should be stretched (or shrunk) to the template dimensions or just centered 'as-is'.

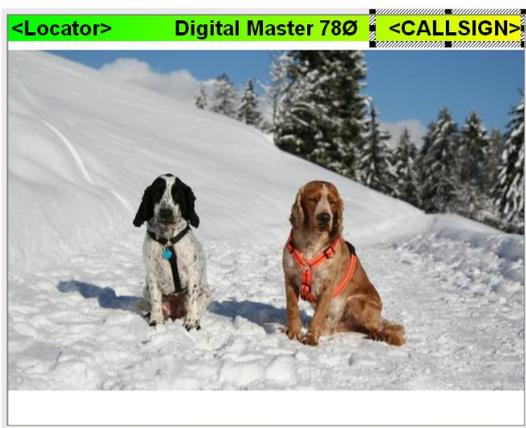

## Adding Text

Next add text areas. Just click anywhere in the template and drag to create a new area.

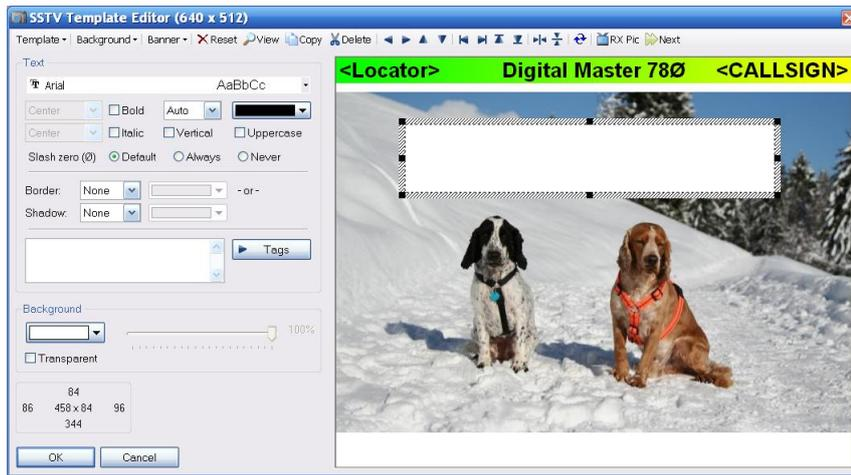

The new area is just above the two dogs. By default the text colour is black, the background is white. The default font is Arial.

Enter the text, for example **CQ de HB9DRV**.

Select special effects such as Border and / or Shadow. Be aware that a fancy template will not be as easy to read under poor conditions as a simple template.



In this example the text format has been modified:

- 4 pixel yellow border,
- Transparent,
- 8 pixel shadow,
- Centered horizontally.

You can use tags instead, for example for his callsign. Just click the Tags button and select from the popup menu.

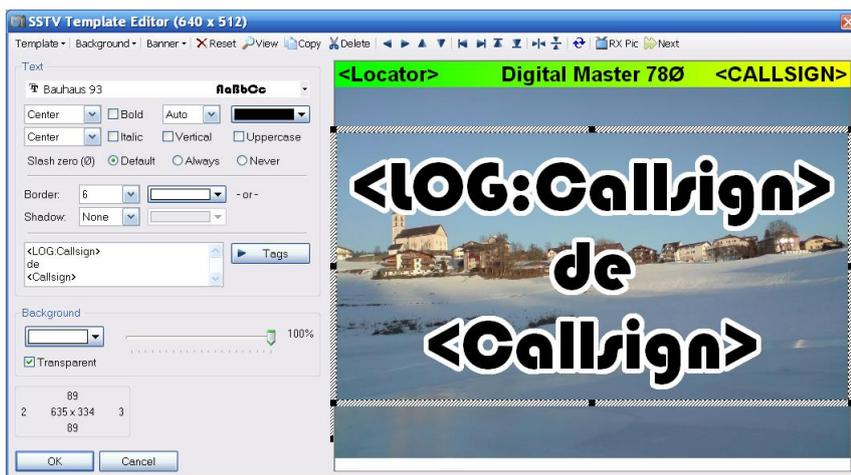

Here tags are used for his callsign (the value is taken from the Add Log Entry window) and my callsign (the value is taken from the Tags).

## Saving

Now press OK - you are prompted for a filename. Enter something which describes the template's use.

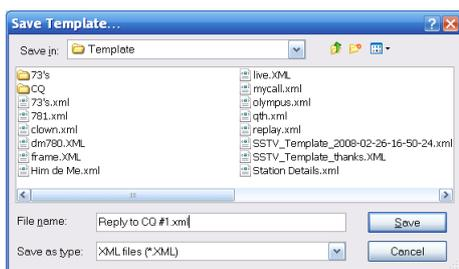

The template is shown with the current tag values, in this example GD4ELI has been entered in the Add Log Entry window.



# FTP

To automatically upload received images to your web site using FTP select FTP from the toolbar.

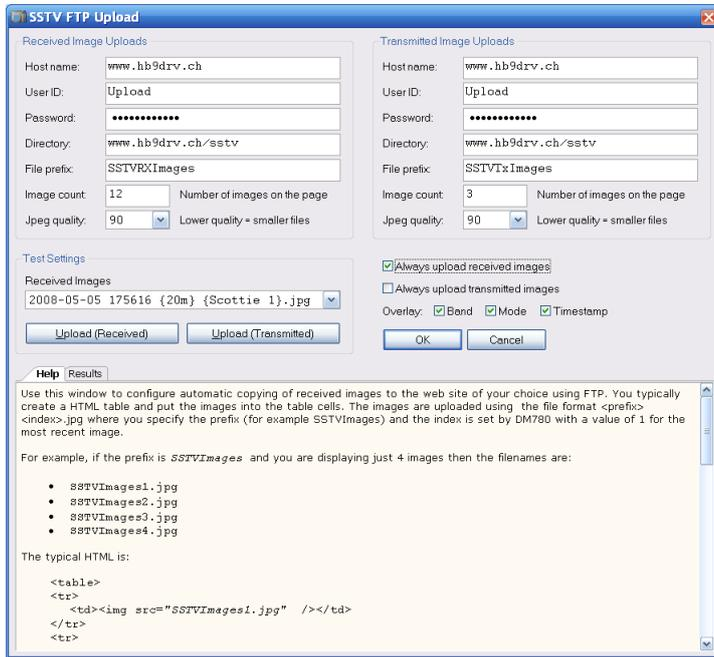

There are separate parameters for uploading transmitted and received images, both of which are optional. In the above example only received images are uploaded.

Press Upload (Received) and Upload (Transmitted) to test the settings.

Optionally overlay Band, Mode and Frequency on the uploaded images. Here's an example uploaded by G0HWC, a Scottie 2 image received on 20m on March 5<sup>th</sup>, 2008.

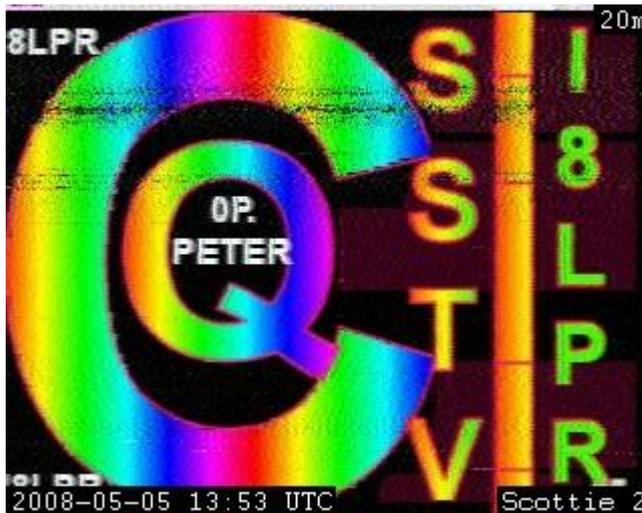

RX and TX upload are also enabled from the SSTV toolbar.





## Image Window

The image window shows the received and transmitted images as well as optional webcam support.

### Receive Window

-  On Enable SSTV decoding
-  AFC Enable automatic frequency control (image must have started with a VIS code)
-  TX: Edit Edit the TX template (or just double-click in the received image)
-  Autostop Stop decoding when sync pulses are no longer detected
-  Default the current image with the default Windows image viewer
-  Erase the window
-  Display the image with the experimental image post-processing
-  Save the image to a file
-  Enable image autosave
-  Reset Reset the decoder, erase current image
-  TX Start transmit

### Transmit Window

-  Edit Edit the TX template (or just double-click in the received image)
-  Default the current image with the default Windows image viewer
-  Erase the window
-  Refresh the window
-  Image Select a background image (or just double-click an image in the Saved Imaged window).
-  BBC The famous BBC test card used from 1967 to 1999
-  Phillips Reset the decoder, erase current image
-  TX Start transmit

### Webcam

The webcam support uses the Windows AVICap video capture class, this supports most modern webcams.

Webcams are supported so that you can add a picture of your magnificent self to the transmit window with a single click.

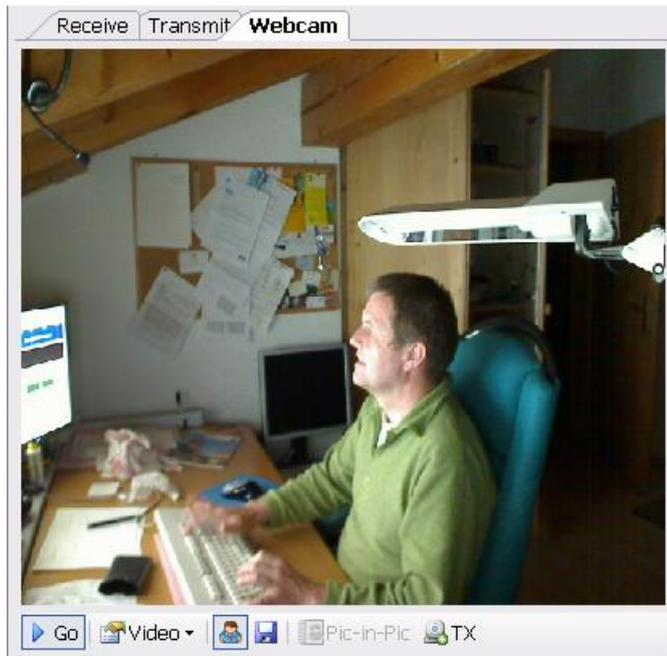

In the above example an unknown programmer is shown slaving over a hot keyboard.

The options:

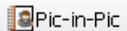
-  Start the webcam interface
-  Select the webcam source and format
-  Live preview
-  Save current image to the *TX: Background Images* window
-  Copy the current image to the TX template's picture-in-picture field
-  Copy the current image to the transmit window

# Callsign Lookup

Throughout DM780 you will frequently want to find details of another station. DM780 supports both file and internet- lookups using [QRZ.com](http://www.qrz.com).

Select *Callsign Lookup* from the *Tools* menu to configure callsign lookup.

The callsign lookup sequence is:

1. CD - HamCall,
2. CD - QRZ.com,
3. Internet using QRZ.com's subscription interface,
4. Internet using the QRZ.com detail page in a browser window.

As soon as any data is found the search stops.

---

## CD Lookups

The CD's from <http://www.qrz.com/> and <http://hamcall.net/> are supported. The HamCall CD provides more data than the QRZ.com CD. For best performance copy the files from CD to hard disk.

---

## QRZ.com

### Subscriptions

Access to the QRZ data online requires a valid subscriber login consisting of a username and password, and a current, active subscription with QRZ. You can use your QRZ.com username and password for seven days from the date of first lookup. For more information please visit <http://online.qrz.com/>.

### Web Browser

Lookups are performed by opening the callsign's detail page in an Internet Explorer browser which is built into DM780. This is not very efficient, the QRZ subscriptions method is far better.

## Donations

Just like Ham Radio Deluxe, QRZ.com has considerable costs associated with providing the online callsign database.

Please consider donating to QRZ.com by visiting <http://www.qrz.com/i/donations.html>. Another option is to subscribe to QRZ.com - this information is found by visiting the site.

# Logbook

Every modern program has a built-in logbook; DM780 is no exception. The database engine is taken from Ham Radio Deluxe; the operation will be familiar to anyone who has used Ham Radio Deluxe.

There are two logbook windows:

- Quick log - a docking pane that shows the most recent entries, designed as a quick reference window.
- Main logbook - this is the option you select for general logbook maintenance.



Whichever window you use – TAKE REGULAR BACKUPS!

## Quick Log

Select *Display Quick Log* from the *Logbook* menu or *Quick Log* from the *View* menu to display this window.

Much simpler than the main logbook window, this is a docking pane with only the most basic options available, selected from the toolbar.

Date	Start	End	Station	Band	Mode	Sent	Recv	Locator	Name
31/01/2007	08:09	08:29	LAØHK	40m	LSB	59	59		Gerald Markesc
26/01/2007	21:33	21:38	LAØBX	80m	PSK31	599	599		Jonsson
06/01/2007	08:08	08:19	LAØHK	40m	LSB	59	59		Gerald Markesc
02/01/2007	08:08	08:16	LAØHK	40m	LSB	59	59		Gerald Markesc
18/11/2006	08:11	08:18	LAØHK	40m	LSB	59	59		Gerald Markesc
15/11/2006	08:17	08:19	LAØHK	40m	LSB	59	59		Gerald Markesc
09/11/2006	08:06	08:19	LAØHK	40m	LSB	59	59		Gerald Markesc

- Fit to Text
- Refresh
- Modify
- Delete

-  Max Entries
-  Plot
-  Backup
-  Enable Filter (find by callsign)
-  Options

If the  *Find* option is enabled then any callsign entered in the *Add Log Entry* window is automatically applied here.

To try this:

1. Make sure the *Quick Log* window is displayed.
2.  *Find* must be selected.
3. In the *Add Log Entry* window enter a callsign in the *Callsign* field.

All previous QSO's with this station are now shown.

## Main Logbook

Select *Display Main Logbook* from the *Logbook* menu or press the *Logbook* button on the main toolbar.

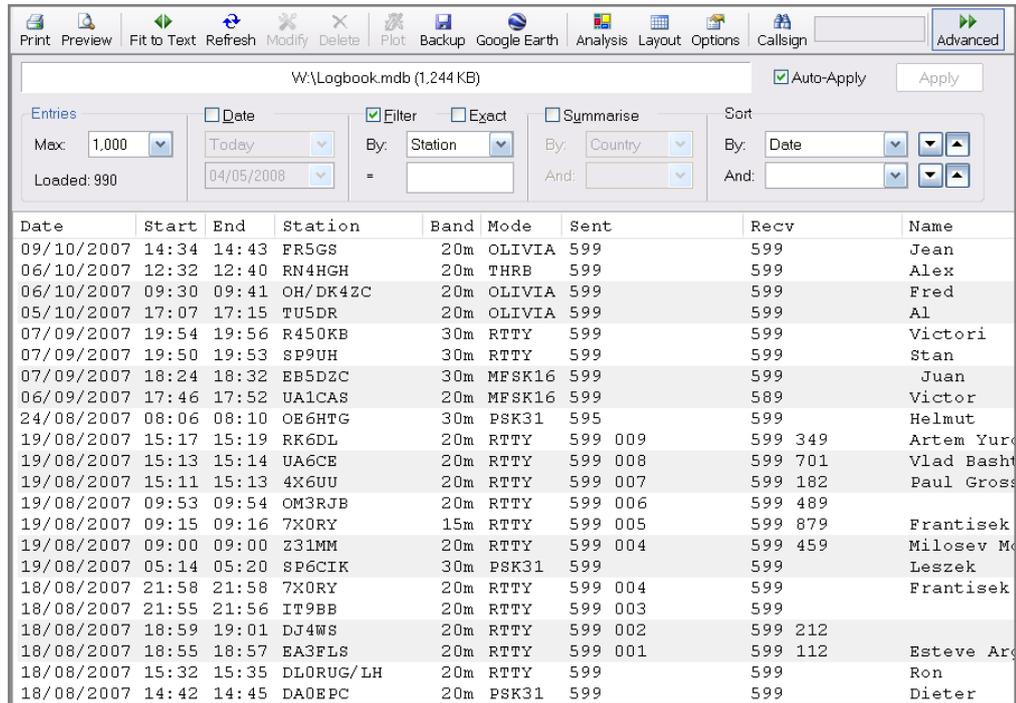

The screenshot shows the 'Main Logbook' window with the following data:

Date	Start	End	Station	Band	Mode	Sent	Recv	Name
09/10/2007	14:34	14:43	FR5GS	20m	OLIVIA	599	599	Jean
06/10/2007	12:32	12:40	RN4HGH	20m	THRB	599	599	Alex
06/10/2007	09:30	09:41	OH/DK4ZC	20m	OLIVIA	599	599	Fred
05/10/2007	17:07	17:15	TU5DR	20m	OLIVIA	599	599	Al
07/09/2007	19:54	19:56	R450KB	30m	RTTY	599	599	Victori
07/09/2007	19:50	19:53	SP9UH	30m	RTTY	599	599	Stan
07/09/2007	18:24	18:32	EB5D2C	30m	MFSK16	599	599	Juan
06/09/2007	17:46	17:52	UA1CAS	20m	MFSK16	599	589	Victor
24/08/2007	08:06	08:10	OE6HTG	30m	PSK31	595	599	Helmut
19/08/2007	15:17	15:19	RK6DL	20m	RTTY	599 009	599 349	Artem Yur
19/08/2007	15:13	15:14	UA6CE	20m	RTTY	599 008	599 701	Vlad Bashi
19/08/2007	15:11	15:13	4X6UU	20m	RTTY	599 007	599 182	Paul Gross
19/08/2007	09:53	09:54	OM3RJB	20m	RTTY	599 006	599 489	
19/08/2007	09:15	09:16	7X0RY	15m	RTTY	599 005	599 879	Frantisek
19/08/2007	09:00	09:00	Z31MM	20m	RTTY	599 004	599 459	Milosev M
19/08/2007	05:14	05:20	SP6CIK	30m	PSK31	599	599	Leszek
18/08/2007	21:58	21:58	7X0RY	20m	RTTY	599 004	599	Frantisek
18/08/2007	21:55	21:56	IT9BB	20m	RTTY	599 003	599	
18/08/2007	18:59	19:01	DJ4WS	20m	RTTY	599 002	599 212	
18/08/2007	18:55	18:57	EA3FLS	20m	RTTY	599 001	599 112	Esteve Arc
18/08/2007	15:32	15:35	DL0RUG/LH	20m	RTTY	599	599	Ron
18/08/2007	14:42	14:45	DA0BPC	20m	PSK31	599	599	Dieter

Note: The selection fields at the top of the window are enabled when the *Advanced* button is pressed.

All options are selected from either the Logbook menu, the context (right-click) menu or the toolbar.

## Layout

The column layout is user-definable. Select the columns and the order in which they are displayed.

Save up to four custom layouts.

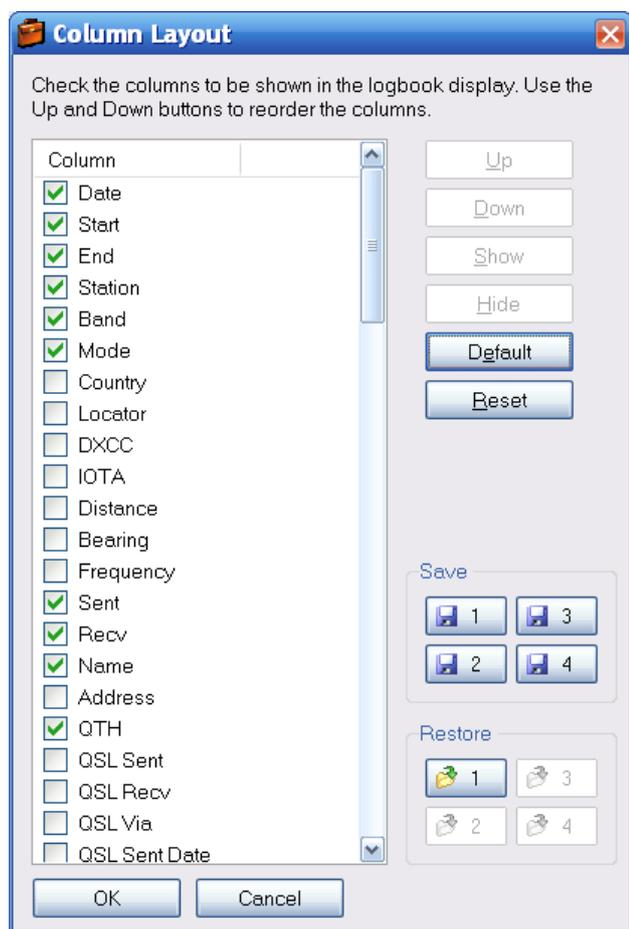

## ADIF

Amateur Data Interchange Format (ADIF) files are used to exchange QSO information between logging programs. In DM780 you can save (export) the logbook to an ADIF file and load (import) an ADIF file into the logbook.

### *Export*

Create and ADIF file to send your records to another logging program, Logbook of The World (LoTW) or eQSL.cc.



After selecting the output file you select the fields to be included in the file.

- ADIF / LoTW: the fields supported by ADIF 2.0 (also required by LoTW).
- ADIF + Ham Radio Deluxe: all fields.
- EQSL: only the fields required by eQSL – this makes the ADIF file smaller and the eQSL upload faster.

An example of an ADIF file containing a single record is shown below:

```
#++
#
#   Digital Master 780 version 1.0 build 1431
#   http://www.hb9drv.ch
#
#   Free software for ever!
#
#   Created:   28-Mar-2007 20:54:55
#   Database:  C:\Documents and Settings\...\HRD Logbook 19-
Mar-2007 230254.mdb
#   Exported: 1 record
#
#--

<ADIF_VERS:3>2.0
<PROGRAMID:14>HamRadioDeluxe
<PROGRAMVERSION:22>Version 1.0 build 1431
<EOH>

<call:5>NP2KW <qso_date:8:d>20070201 <time_on:6>091822
<band:3>40m <mode:5>PSK31 <rst_sent:4>599 <a_index:2>18
<cont:2>NA <dxcc:3>285 <freq:8>7.034500
<gridsquare:6>FK77np <iota:6>NA-106 <k_index:1>4
```



```

<my_city:8>Wickford <my_cnty:5>Essex
<my_country:7>England <my_cq_zone:2>14
<my_gridsquare:6>JO01go <my_iota:6>EU-005
<my_itu_zone:2>27 <my_lat:8>51.60545 <my_lon:7>0.54845
<my_name:5>Terry <my_postal_code:8>SS11 8XN
<my_rig:33>Yaesu FT1000 MkV + Balanced tuner
<my_street:18>2 Coltishall Close <name:5>Manny
<operator:5>G6CNQ <owner_callsign:5>G6CNQ <qth:18>St
Croix, Vi 00821 <rst_rcvd:4>599 <sfi:2>89
<station_callsign:5>G6CNQ <time_off:6>092252 <tx_pwr:8>40
watts <EOR>

```

## Import

Use this option to load and ADIF file into your logbook database.

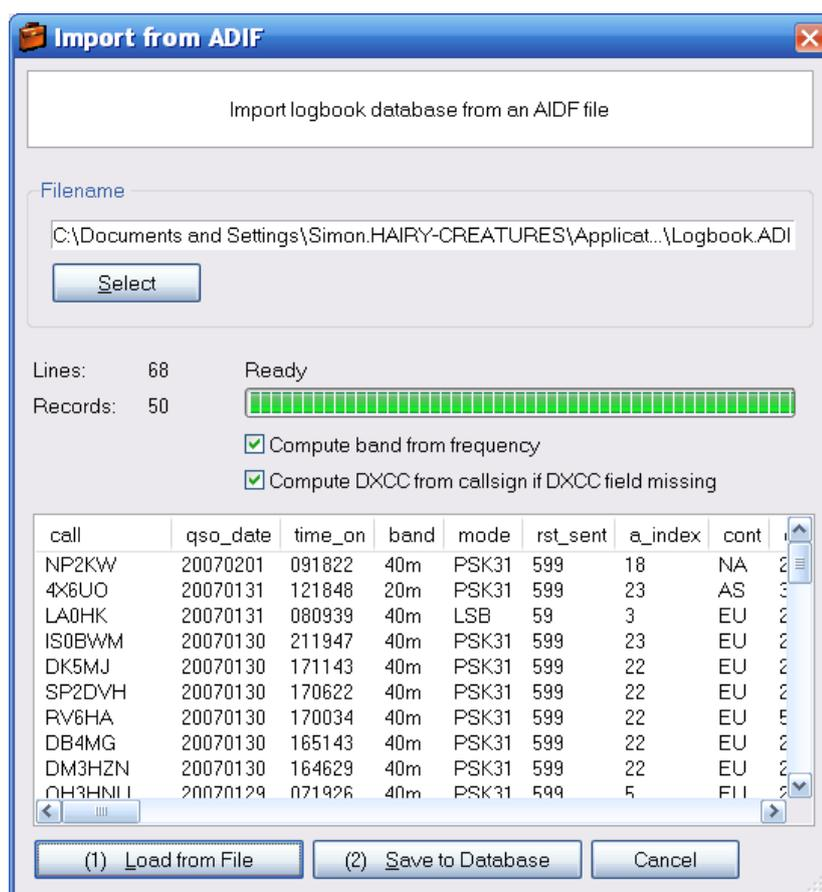

When importing an ADIF file the band information may be missing, if you check the option:

Compute band from frequency

the band is recomputed.

If the DXCC information is missing you can generate this by checking:

Compute DXCC from callsign if DXCC field missing

The first step is to load the file; the records are shown in the bottom half of the window. If you are satisfied that the information shown is correct you save this information to your database.

## Cabrillo

Many contests require the log in Cabrillo format (why they can't just load an ADIF file is a mystery).

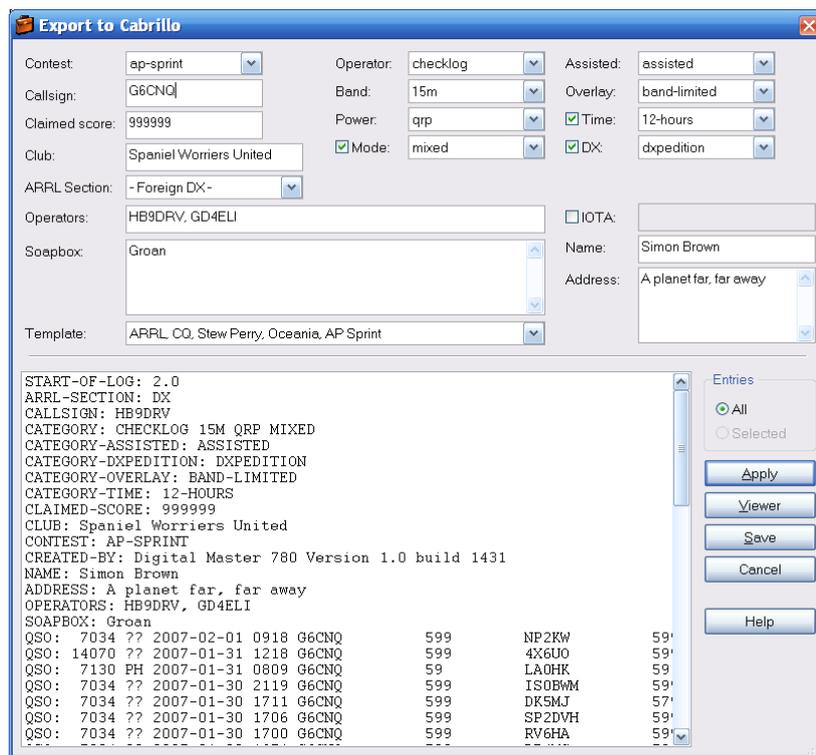

Export to Cabrillo

Contest: ap-sprint Operator: checklog Assisted: assisted  
Callsign: G6CNCQ Band: 15m Overlay: band-limited  
Claimed score: 999999 Power: qrp Time: 12-hours  
Club: Spaniel Worriers United Mode: mixed DX: dpxpedition  
ARRL Section: - Foreign DX -  
Operators: HB9DRV, GD4ELI IOTA:   
Soapbox: Groan Name: Simon Brown  
Address: A planet far, far away  
Template: ARRL, CQ, Stew Perry, Oceania, AP Sprint

START-OF-LOG: 2.0  
ARRL-SECTION: DX  
CALLSIGN: HB9DRV  
CATEGORY: CHECKLOG 15M QRP MIXED  
CATEGORY-ASSISTED: ASSISTED  
CATEGORY-DXPEDITION: DXPEDITION  
CATEGORY-OVERLAY: BAND-LIMITED  
CATEGORY-TIME: 12-HOURS  
CLAIMED-SCORE: 999999  
CLUB: Spaniel Worriers United  
CONTEST: AP-SPRINT  
CREATED-BY: Digital Master 780 Version 1.0 build 1431  
NAME: Simon Brown  
ADDRESS: A planet far, far away  
OPERATORS: HB9DRV, GD4ELI  
SOAPBOX: Groan

QSO:	7034	??	2007-02-01	0918	G6CNCQ	599	NP2KW	59'
QSO:	14070	??	2007-01-31	1218	G6CNCQ	599	4X6UO	59'
QSO:	7130	PH	2007-01-31	0809	G6CNCQ	59	LA0HK	59'
QSO:	7034	??	2007-01-30	2119	G6CNCQ	599	IS0BWM	59'
QSO:	7034	??	2007-01-30	1711	G6CNCQ	599	DK5MJ	57'
QSO:	7034	??	2007-01-30	1706	G6CNCQ	599	SP2DVH	59'
QSO:	7034	??	2007-01-30	1700	G6CNCQ	599	RV6HA	59'

Not all Cabrillo templates are supported - these are added as required.

## Merge HRD

You can load (import) records from another logbook providing it is already in the HRD format.

Typical use would be to import a database created during a contest of an expedition to an exotic location or while using your laptop from a portable site.

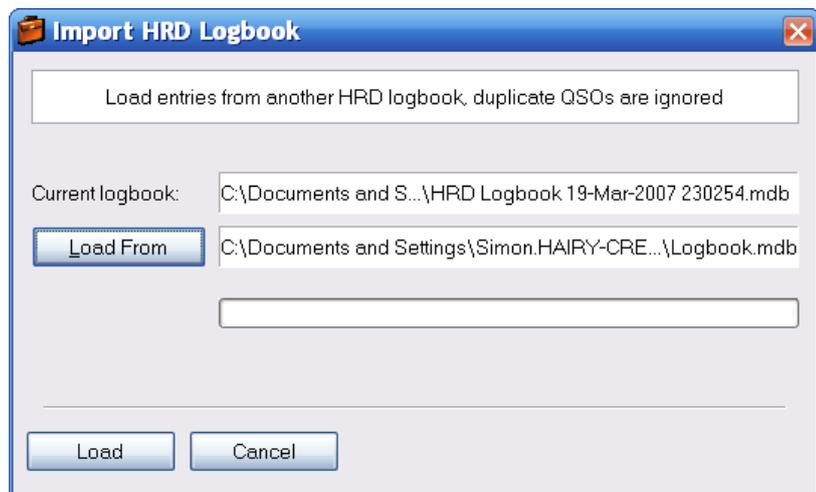

Import HRD Logbook

Load entries from another HRD logbook, duplicate QSOs are ignored

Current logbook: C:\Documents and S...\HRD Logbook 19-Mar-2007 230254.mdb  
Load From: C:\Documents and Settings\Simon.HAIRY-CRE...\Logbook.mdb

Load Cancel

Duplicate QSO's are ignored when you press *Load*.

## Google Earth

Selected entries can be sent to Google Earth, a fantastic program available for free download.

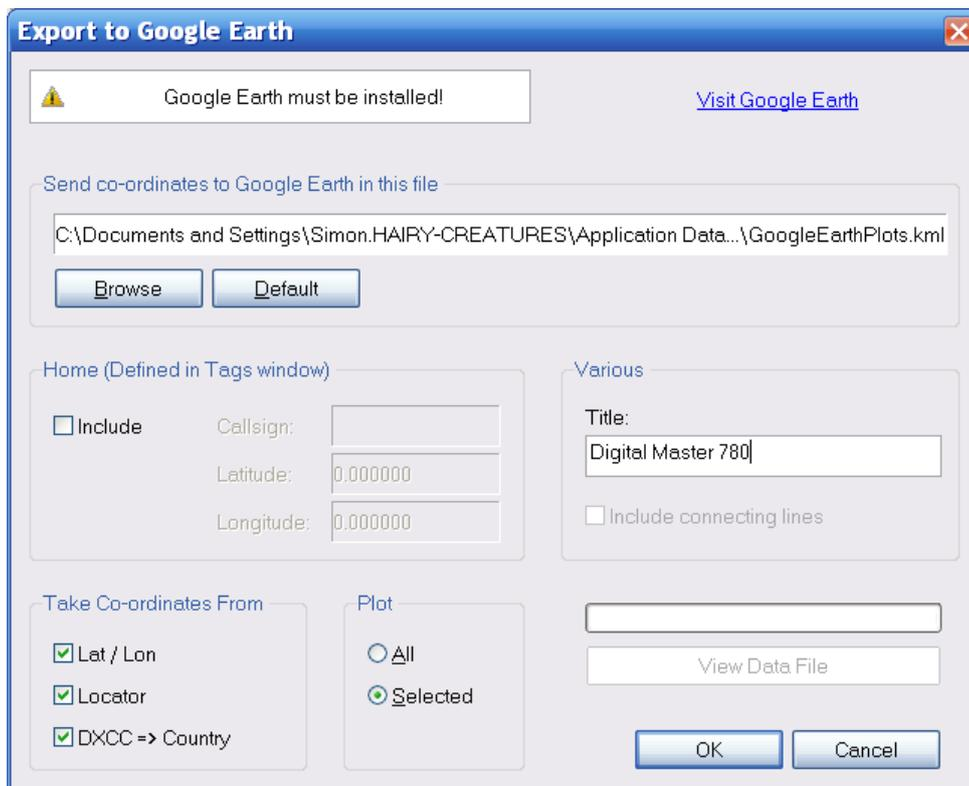

The interface to Google Earth is a Keyhole Markup Language (kml) file.

---

Note: Home information is taken from the *Tags* window shown in the QSO Windows.

---

Tags	
About Me	
Callsign	hb9drv
Name	Simon
Age	84
Locator	JN46pt
QTH	Laax
E-Mail	simon@hb9drv.ch
HomePage	www.hb9drv.ch
Clubs	Far too many

## Options

The logbook options are selected from the Logbook entry. The options should be self-explanatory, a few of the more important options are discussed below.

## Countries File

Nothing stays the same forever, especially country prefixes. The *Countries File* option on the *Files, Backups* page is used to either load a new file or edit the current file.

## eQSL.cc

I use eQSL.cc as it has a simple and fast programming interface – try it.

## QSO Forwarding

Forward QSOs to DXbase as they are added to the DM780 logbook. Please note that the interface supplied by DXbase does not allow DM780 to send over date and time files, DXbase uses the current time.

---

## Analysis

The current analysis shows DXCC, IOTA, QSO and Grid squares by band and mode.

Printing is supported!

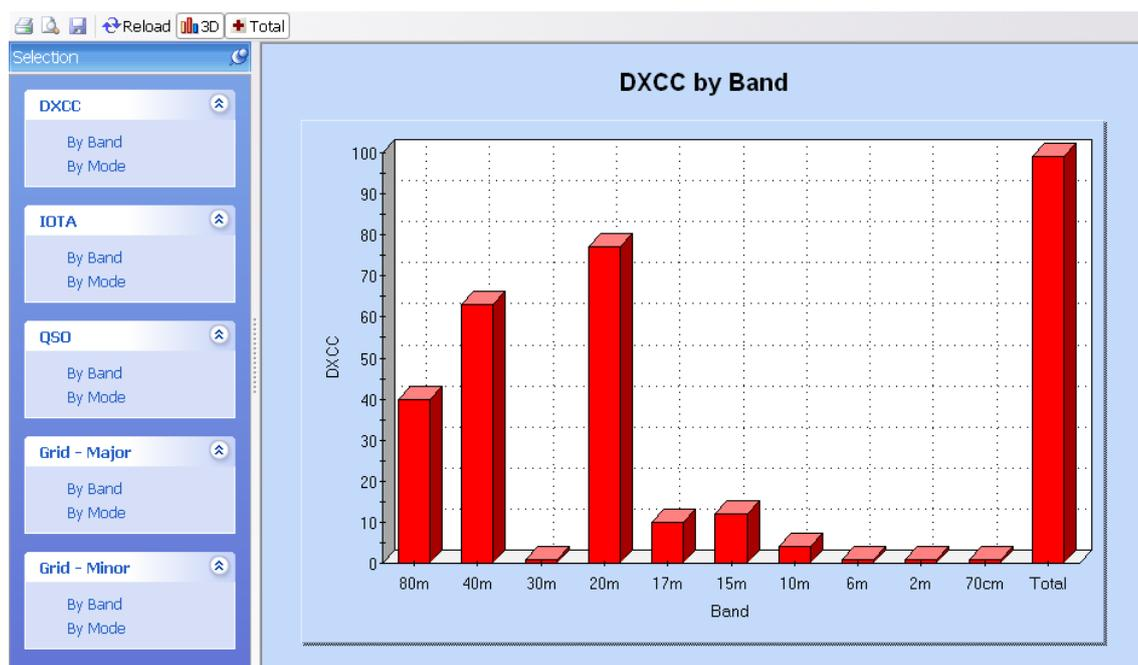

# SuperBrowser

The aim of the SuperBrowser is to display as many PSK QSO's as possible.

Not only display – you can have a QSO using the SuperBrowser!

A standard display is shown below. From left to right:

- Frequency,
- Waterfall,
- Active channels.

At the bottom you see the status bar, containing:

- Current soundcard selection,
- Active channel count / total channels,
- Hold time before a channel is no longer shown,
- Audio rewind when a new signal is detected,
- CPU used by the background SuperBrowser processing,
- Overload status (incoming signal level is too high),
- Current AFC setting.

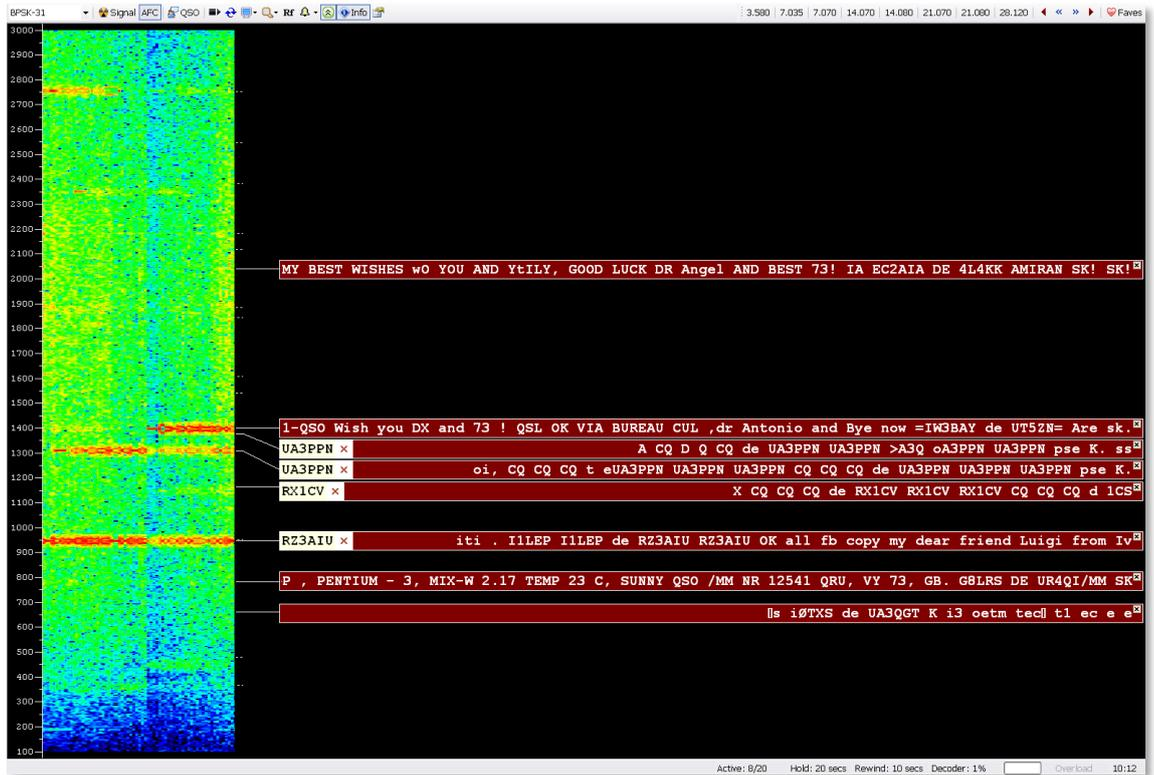

In this example the callsign RX1CV has been reliably identified, so is shown at the beginning of the channel.

The **X** icon indicates that you have not worked RX1CV on this band. If you have worked RX1CV the **✓** icon is displayed.

## Options

### Main Toolbar

The main toolbar options are:

-  Mode selection
-  Squelch level and decoding threshold
-  AFC
-  Display the QSO windows – you can transmit with the SuperBrowser!
-  Plot
-  Backup
-  Show radio frequency
-  Enable alarms
-  Maximise contrast
-  Waterfall display mode
-  Number of channels

-  Info Enable info popups showing station worked status (band, time etc.)
-  Options

## Favourites Toolbar

The favourites toolbar contains the frequencies you commonly use, it is provided to make switching between these frequencies as painless as possible.

-  A favourite frequency, not selected.
-  The currently selected favourite frequency.
-  Adjust frequency by +/- 500Hz.
-  Start the favourites manager.

---

## Transfer To QSO Window

Double-click on a channel to transfer the settings and data to a main QSO window (not the built-in QSO window).

Press shift and click on a channel to open the SuperBrowser QSO window (if not already open) and select the channel.

## QSO Window

Press the  QSO button to display the SuperBrowser QSO windows:

- Add Log Entry,
- QSO: RX,
- QSO: TX.

These windows are the same as those in the main QSO window (page 19).

Click anywhere in the channel text (not the callsign or icons) to select a different channel.

Click anywhere in the waterfall to change the frequency of the current channel.

---

## Options

Press *F8* to display the *Program Options* (or select *Program Options* from the *Tools* menu), then select the *SuperBrowser:1* or *SuperBrowser:2* page to view the available options.

## Visual

The SuperBrowser:1 page concentrates on the appearance of the SuperBrowser.

The screenshot shows the SuperBrowser:1 configuration page. At the top, there are two call sign indicators: "GD4ELI" with a close button and "HB9DRV" with a checkmark. Below them are two lines of text: "CQ DX CQ DX CQ DX de GD4ELI GD4ELI GD4ELI" and "for the call, I am using DM780 and an Electaft K3". The main configuration area is divided into several sections:

- Appearance:** Includes a checkbox for "Display 0 instead of 0 (zero)", radio buttons for "Text case" (Default, Lower, Upper), a "Font" section with "Bold" checked, "Italic" unchecked, and "Size: 12", and a font dropdown menu set to "Courier New".
- Locators:** Includes a checkbox for "Display distance and bearing from my locator (see Tags window)" and radio buttons for "Units" (Kilometers, Miles).
- Colours:** Features dropdown menus for "Display", "Callsign", "Channel", and "QSO", each with "Background", "Text", and "Border" options. A checkbox is present for "Use alternate colours for the SuperBrowser QSO channel (if selected)".

At the bottom right, there is a "Defaults" button and two links: "See also: SuperBrowser:2" and "See also: Waterfall".

## Operation

The SuperBrowser:2 page concentrates on the way the SuperBrowser operates.

The screenshot shows the SuperBrowser:2 configuration page. It is divided into several sections:

- Show Channel:** Includes a "Show the channel when" section with dropdowns for "characters received" (set to 10) and "containing a word of at least" (set to 4) characters. Below this are radio buttons for "Rewind received audio" (None, 5 secs, 10 secs, 15 secs, 20 secs, 25 secs, 30 secs, All).
- Hide Channel:** Includes a "Hide an inactive channel after:" section with radio buttons (10 secs, 15 secs, 20 secs, 25 secs, 30 secs, 40 secs, 50 secs, 60 secs) and an "And if less than" section with dropdowns for "characters are received in the last" (set to 2) and "seconds" (set to 4).
- Search:** Includes radio buttons for "Free space algorithm" (Basic, Advanced) and a "Channel min separation:" dropdown set to 5 Hz.
- Waterfall Width:** Includes a "Waterfall width as a %age of total width" section with a slider set to 20 and minus/plus buttons.
- Other:** Includes a checkbox for "Display radio frequency".
- PSK Automatic Propagation Reporter:** Includes "Options" and "Homepage" buttons.

At the bottom left, there is a "Defaults" button and two links: "See also: SuperBrowser:1" and "See also: Waterfall".



## PSK Propagation Reporter

This is a project to automatically gather reception records of PSK activity from the SuperBrowser window and then make those records available in near real-time to interested parties - typically the amateur who initiated the communication.

*Idea and implementation by Philip Gladstone, N1DQ.*

From the *Tools* menu select *PSK Reporter*, then *Options*.

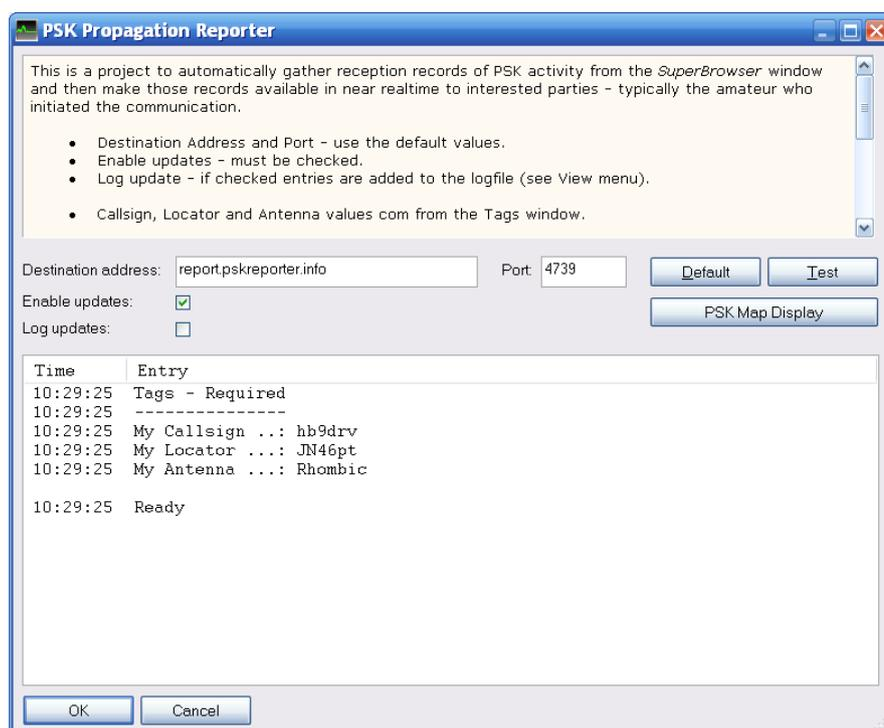

- Destination Address and Port - use the default values.
- Enable updates - must be checked.
- Log update - if checked entries are added to the logfile (see View menu).

When a report is sent it uses the *Callsign*, *Locator* and *Antenna* values com from the *Tags* window.

The way that it works is that many amateurs will run a client that will monitor received traffic for callsigns (the pattern 'de callsign callsign') and, when seen, will report this fact. This is of interest to the amateur who transmitted and they will be able to see where their signal was received. The pattern chosen is typically part of a standard CQ call. The duplicate check is to make sure that the callsign is not corrupted.

The way that this would be used is that an amateur would call CQ and could then (within a few minutes) see where his signal was received. This can be useful in determining propagation conditions or in adjusting antenna and/or radio parameters. It will also

provide an archive of reception records that can be used for research purposes.

To show the current reports select *PSK Reporter*, then *Homepage*.

An example of the output is shown below. Here we see the stations received by HB9DRV on 20m on the morning of March 6<sup>th</sup>, 2008.

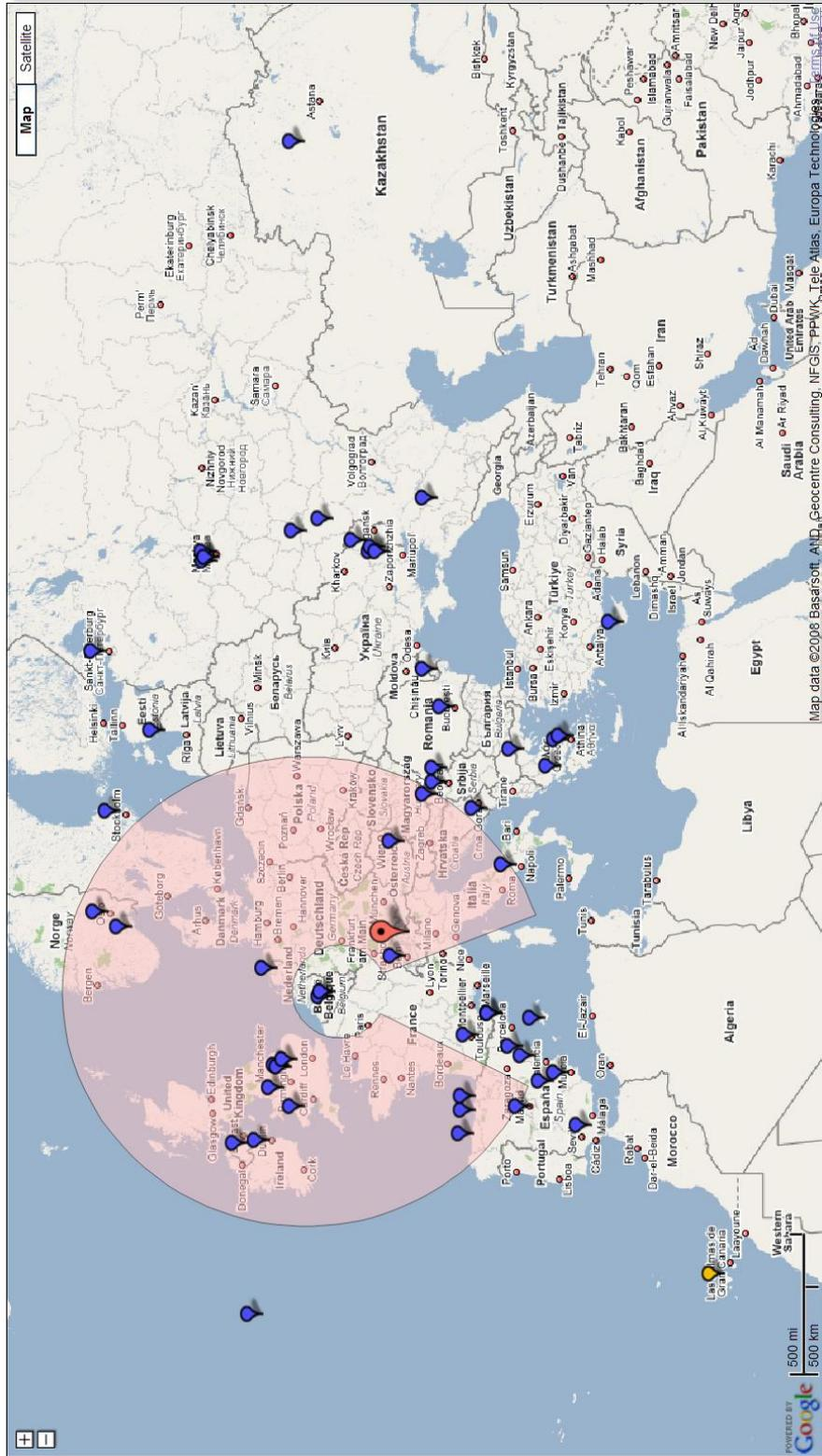

# Web Browsers

DM780 offers two styles of web browser:

- A fully featured full-sized browser, and
- A small docking mini-browser.

The options available in the mini-browser are a subset of those available in the full-sized browser.

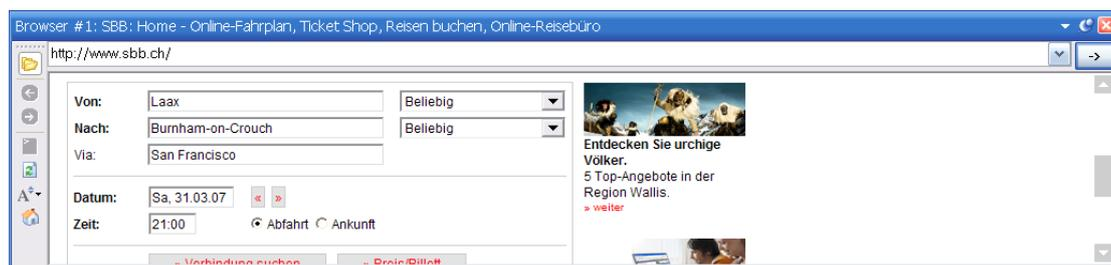

Both browsers use on the Internet Explorer engine, any settings you make with Internet Explorer are automatically applied here.

Options are selected from the toolbars and the *Browser* menu. As an experienced Internet user you will already be familiar with the operation of a web browser.



# World Map

The world map is used to:

1. Plot the greyscale line,
2. Show a locator square overlay,
3. Plot stations as you work them,
4. Plot locators as they are detected in the SuperBrowser.

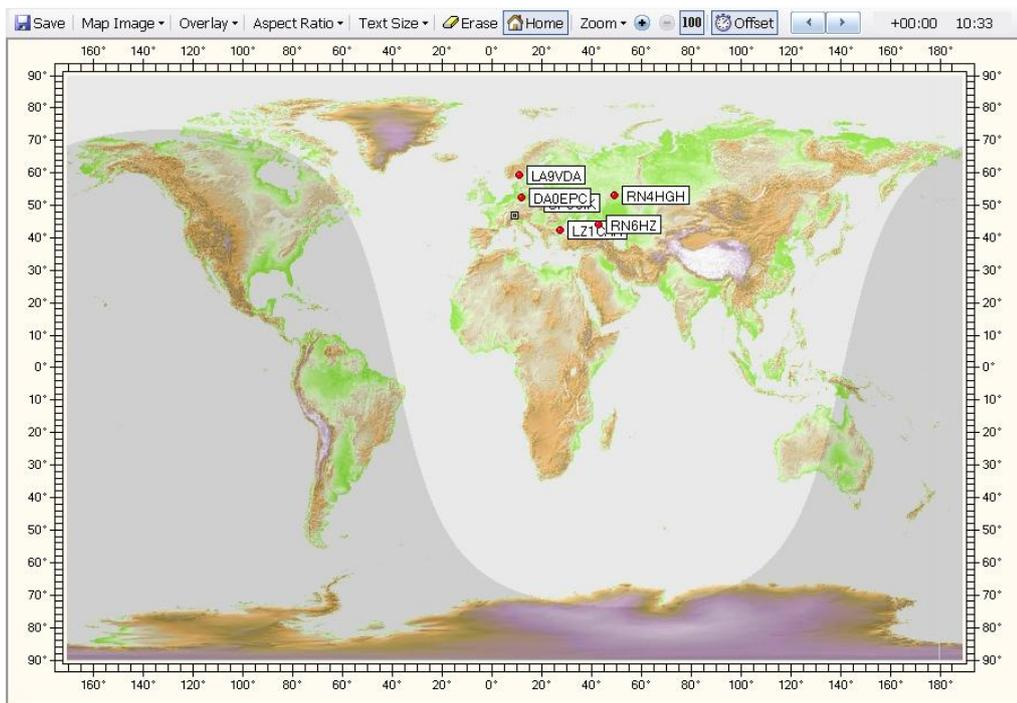

The options are selected from the World map menu and the toolbar.



# Alarms

In the QSO windows you use alarms to monitor received text for special callsigns, locators or any string you want.

## Manager

To define alarms select *Alarms Manager* from the *Tools* menu.

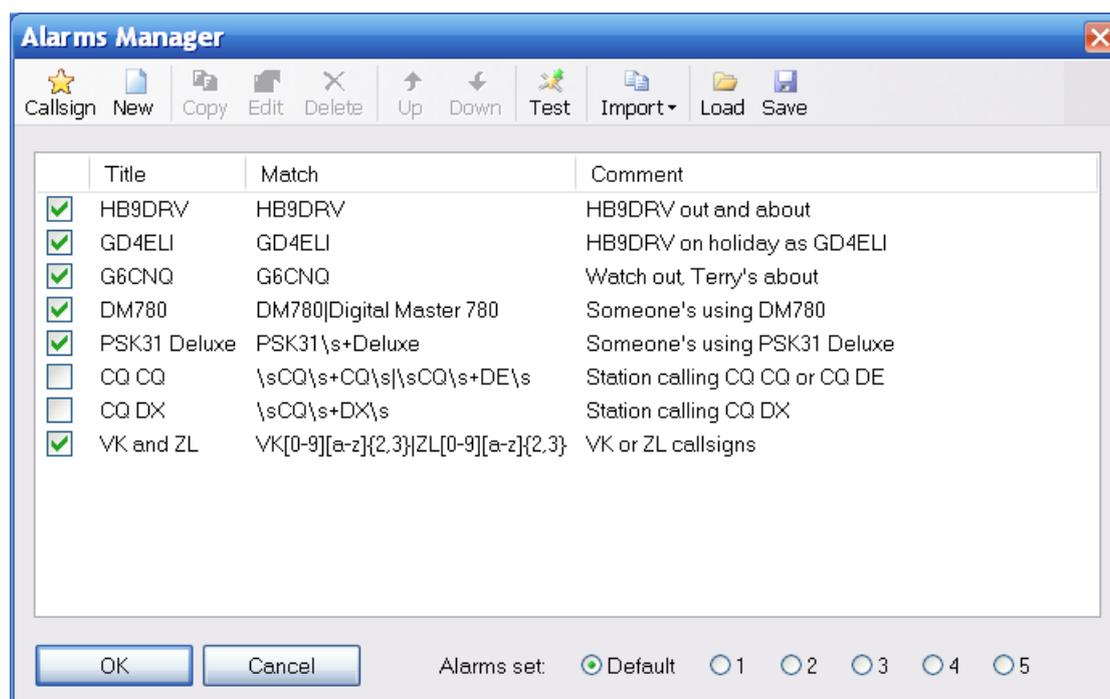

The options are selected from the toolbar.

-  **Callsign** Create a 'quick' alarm definition from a callsign.
-  **New** Create a new alarm definition.
-  **Copy** Copy the currently selected definition.
-  **Edit** Edit the currently selected definition.
-  **Delete** Delete the currently selected definitions.
-  **Up** Move the currently selected definition up.
-  **Down** Move the currently selected definition down.
-  **Test** Text the enabled definitions.

-  Import    Import from another Alarms set.
-  Load     Load from a file.
-  Save     Save to a file.

## Editor

The alarms editor is very simple to use, however you must pay attention to the regular expression syntax.

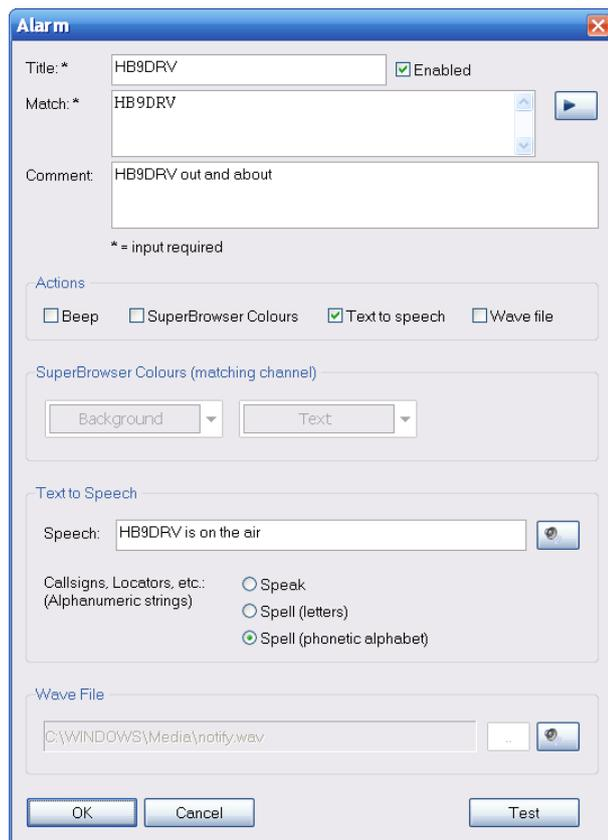

### Match Text

The value in the Match field is a regular expression, examples are shown below. In the table \* represents any character, <spaces> matches one or more spaces.

Match Text	Description
HB9DRV	*HB9DRV*
\sGD[0-9][a-z]{2,3}\s	Any callsign following a space (\s) starting with GD, then a digit (0 to 9), then 2 or 3 letters (a to z).
DM780 Digital Master 780	*DM780* or ( ) *Digital Master 780*
PSK31\s+Deluxe	*PSK31<spaces>Deluxe*



<code>\sCQ\s+CQ\s \sCQ\s+DE\s</code>	<space>CQ<spaces>CQ<space> or <space>CQ<spaces>DE<space>
<code>\sCQ\s+DX\s</code>	<space>CQ<spaces>DX<space>
<code>VK[0-9][a-z]{2,3} ZL[0-9][a-z]{2,3}</code>	Any VK or ZL callsign

The most commonly used regular expression syntax is:

Expression	Matches
<code>.</code>	Any Character
<code>[]</code>	Character in Range
<code>[^]</code>	Character Not in Range
<code>^</code>	Not
<code> </code>	Or
<code>*</code>	0 or More Matches
<code>?</code>	0 or 1 Matches
<code>+</code>	1 or More Matches
<code>{2,4}</code>	2 to 4 Matches

### Some Examples

<code>\s</code>	Single Space
<code>\s+</code>	1 or More Spaces
<code>[a-z]</code>	A to z
<code>[a-z0-9]</code>	A to z or 0 to 9
<code>[abx]</code>	a, b or x
<code>[0-9]</code>	0 to 9
<code>[347]</code>	3, 4 or 7
<code>CQ\s*DX</code>	CQ DX
<code>[gm][a-z]?[0-9][a-z]{2,3}</code>	A UK Callsign starting with G or M
<code>hb9drv</code>	HB9DRV
<code>[a-z]{2}[0-9]{2}[a-z]{2}</code>	Locator (e.g. JN46pt)

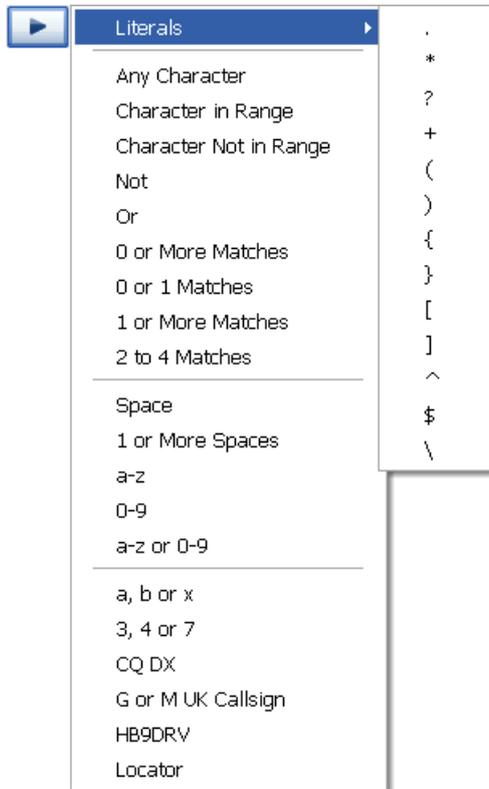

If you use the dropdown menu you can build your own regular expressions.

Use the *Test* option to check your definitions.

## Testing Alarms

Use the *Test* option to compare a string with the enabled definitions.

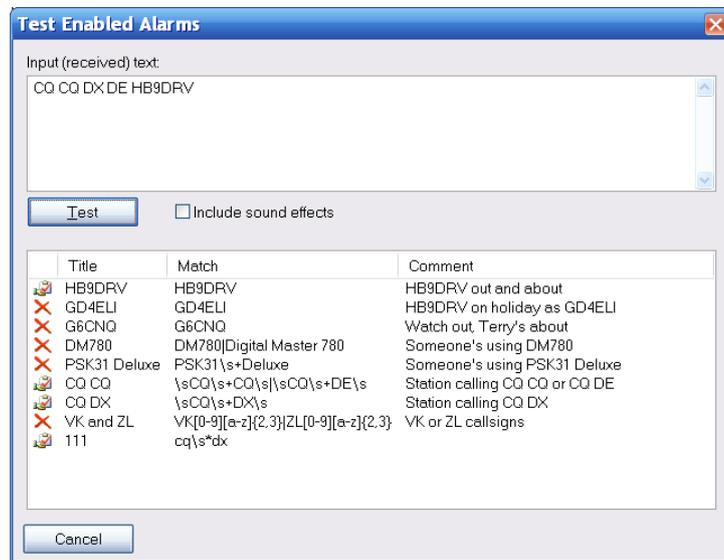

Enter text in the top window, then press Test. The alarm definitions which match are flagged with , those which do not match with .

Check  *Include sound effects* if you want to hear the alarms.

---

## SuperBrowser Colours

Optional colours applied to the SuperBrowser channel which generated the alarm.

---

## Text-To-Speech

DM780 alarms use Microsoft's Text-to-Speech solution. This is usually installed by default on Windows XP and VISTA systems.

If your computer doesn't have Text-to-Speech installed you can download it from [Microsoft's website](#).



# Identities

The concept of multiple identities used in DM780 is similar to that found in Outlook Express.

Typical use of multiple identities:

- At home,
- Portable,
- Contest.

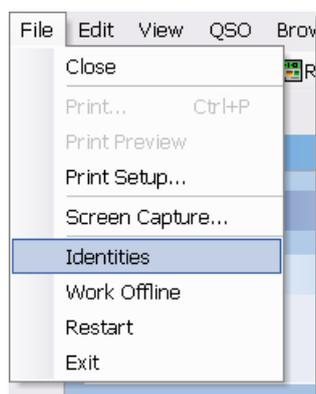

All identities share the same logbook but are otherwise unique (macros, tags, layouts).

Identity support is selected from the File menu.

The Main Identity is used by default. To create / delete an identity use the *New* and *Remove* options.



To reset an identity (remove all files and clear registry settings) press *Reset*. You cannot reset the Main Identity.

---

Note: The logbook database and registry settings are never removed.

---

When you press *Select* DM780 closes and restarts using the selected identity.

---

## Options

When defining an identity you must decide whether to share common definitions with the main identity.

The definitions you can share are:

- Alarms,
- Favourites,
- Macros and
- Tags.

For example, here at the HB9DRV HQ a TS-480SAT and TS-2000 are both used with DM780, but only the TS-480SAT PTT is enabled via HRD whereas the TS-2000 is controlled via a Signalink USB.

So I have two Identities that differ only in the *Program Options* (specifically the PTT page), otherwise they are identical.

# Logfile

The logfile window contains diagnostic information used when there are problems with DM780. You will not normally display this window.

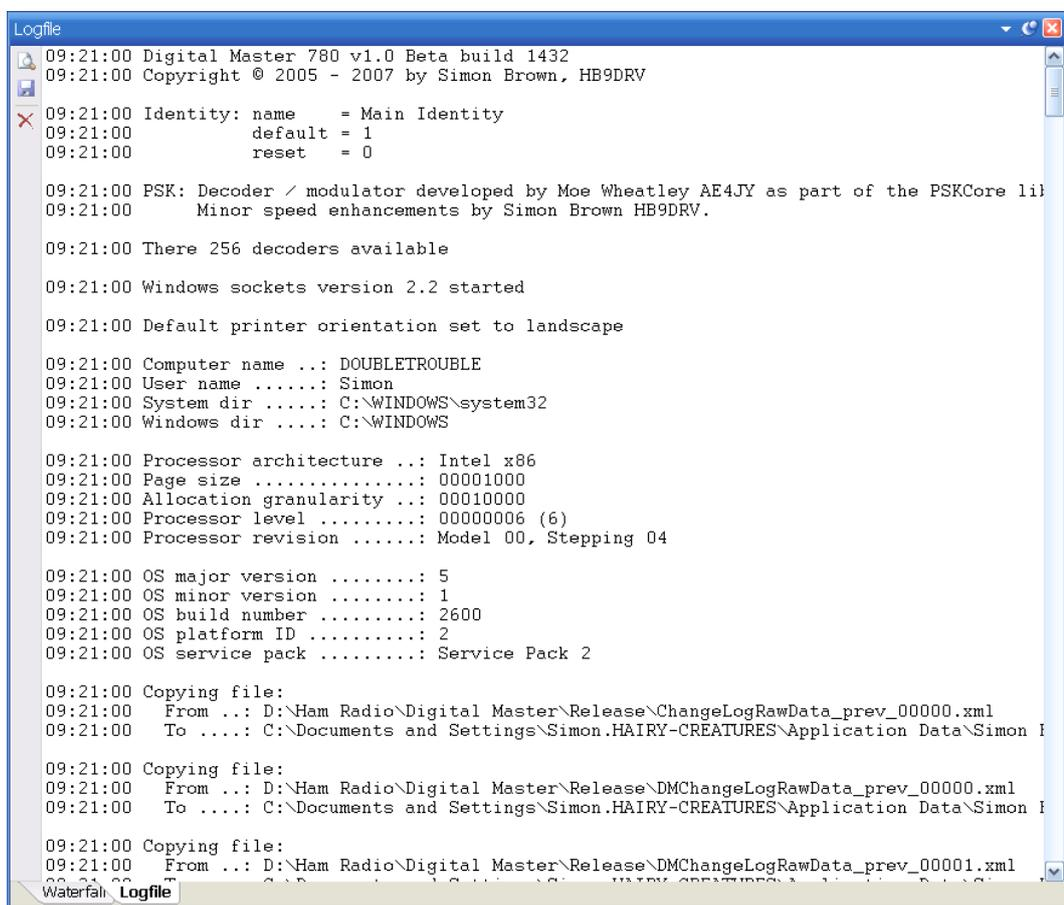

```

Logfile
09:21:00 Digital Master 780 v1.0 Beta build 1432
09:21:00 Copyright © 2005 - 2007 by Simon Brown, HB9DRV
09:21:00 Identity: name    = Main Identity
09:21:00                 default = 1
09:21:00                 reset  = 0
09:21:00 PSK: Decoder / modulator developed by Moe Wheatley AE4JY as part of the PSKCore lib
09:21:00                 Minor speed enhancements by Simon Brown HB9DRV.
09:21:00 There 256 decoders available
09:21:00 Windows sockets version 2.2 started
09:21:00 Default printer orientation set to landscape
09:21:00 Computer name ...: DOUBLETROUBLE
09:21:00 User name .....: Simon
09:21:00 System dir .....: C:\WINDOWS\system32
09:21:00 Windows dir ....: C:\WINDOWS
09:21:00 Processor architecture ...: Intel x86
09:21:00 Page size .....: 00001000
09:21:00 Allocation granularity ..: 00010000
09:21:00 Processor level .....: 00000006 (6)
09:21:00 Processor revision .....: Model 00, Stepping 04
09:21:00 OS major version .....: 5
09:21:00 OS minor version .....: 1
09:21:00 OS build number .....: 2600
09:21:00 OS platform ID .....: 2
09:21:00 OS service pack .....: Service Pack 2
09:21:00 Copying file:
09:21:00   From ...: D:\Ham Radio\Digital Master\Release\ChangeLogRawData_prev_00000.xml
09:21:00   To .....: C:\Documents and Settings\Simon.HAIRY-CREATURES\Application Data\Simon H
09:21:00 Copying file:
09:21:00   From ...: D:\Ham Radio\Digital Master\Release\DMChangeLogRawData_prev_00000.xml
09:21:00   To .....: C:\Documents and Settings\Simon.HAIRY-CREATURES\Application Data\Simon H
09:21:00 Copying file:
09:21:00   From ...: D:\Ham Radio\Digital Master\Release\DMChangeLogRawData_prev_00001.xml
09:21:00   To .....: C:\Documents and Settings\Simon.HAIRY-CREATURES\Application Data\Simon H
Waterfall Logfile

```





# Macros

Macros are used when composing text to be sent during a QSO. Using macros avoids repetitive typing thus ensuring fewer errors.

Typical uses for macros:

- Calling CQ,
- Information about your station,
- Starting a reply.

Macros are selected in the QSO windows from either the Macros window or the Macros toolbar.



## Manager

To define Macros start the Macros Manager:

- Select *Macros Manager* from the *Tools* menu,
- Press Define in the Macros window, or
- Press Define in the toolbar (right-most button).

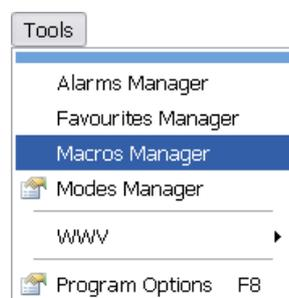

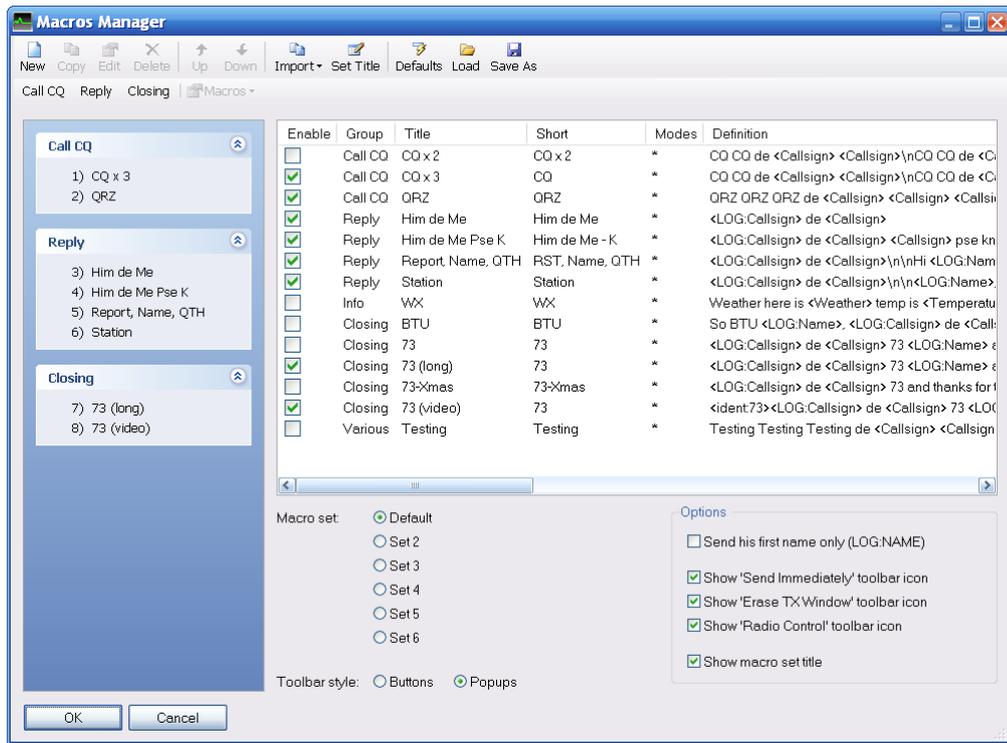

Here you define the macros shown in the macros window *and* the macros toolbar.

The top toolbar contains the Manager options:



- New – create a new macro,
- Copy – copy the selected macro,
- Edit – edit the selected macro,
- Delete – delete the selected macro,
- Up, down – move the selected macro,
- Import – load definitions from another macro set,
- Set Title – the title for the current macro set,
- Defaults – load the default definitions shipped in DM780,
- Load – load definitions from a file,
- Save – save definitions to a file.

The next toolbar shows the enabled definitions as they are shown in the QSO windows.

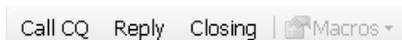

## Editor

The Macro editor window is shown below.

Note: Right-click on an entry in the macros window or macros toolbar to launch the editor without starting the Macros Manager.

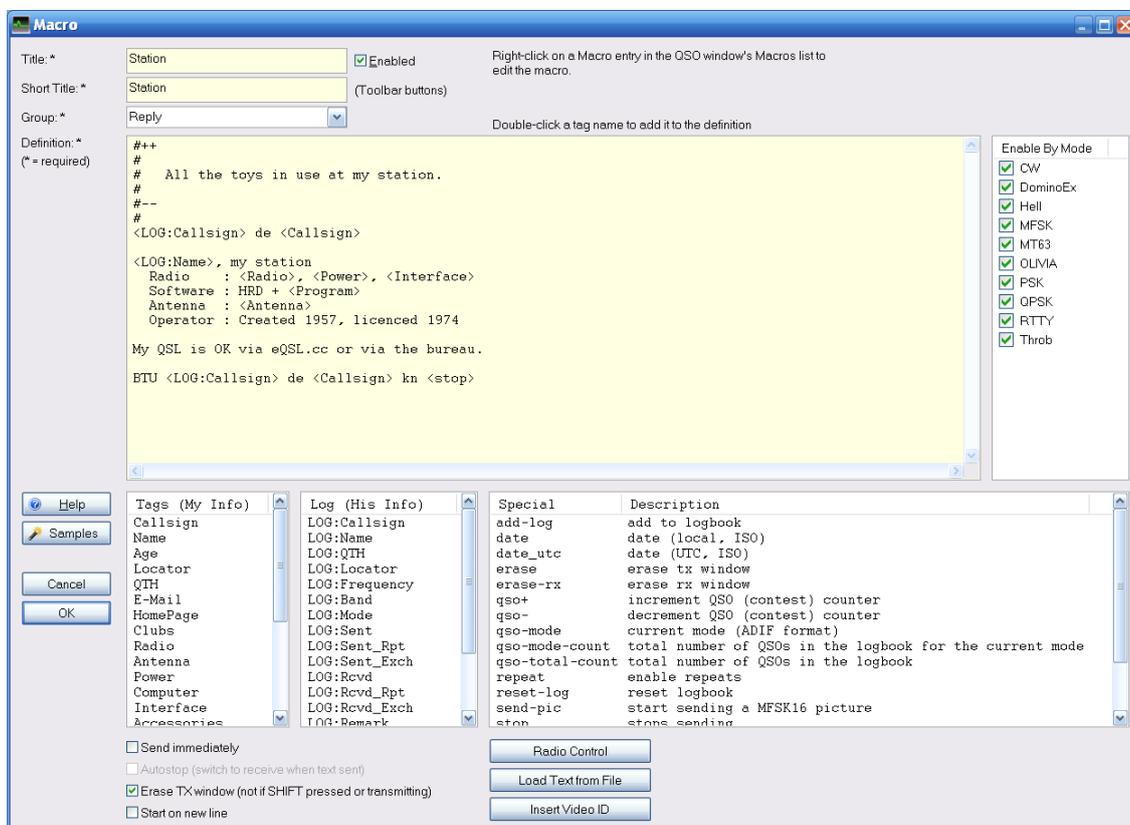

The components of a macro are:

#### *Title*

As shown in the Macros window.

#### *Short Title*

As shown in the Macros toolbar.

#### *Group*

Macros are grouped together in the Macros window (shown in QSO windows).

#### *[X] Enabled*

Only enabled macros are shown in the Macros window and toolbar.

#### *Definition*

See below.

#### *Enable By Mode*

If you want the macro to be available for specific modes only.

#### *Tags (My Info)*

The tags shown in the Tags pane of the normal QSO window, this is information about yourself and your station.

#### *Log (His Info)*

The fields shown in the Add log Entry window where you enter the QSO details before adding to the logbook.

### *Special*

Special tags such as date and time.

#### *[X] Erase TX window...*

If enabled the contents of the transmit window are erase unless *either* Shift is pressed *or* you are transmitting.

#### *[X] Send immediately*

If enabled the macro is sent as soon as it is applied, typically used in a CQ macro.

#### *[X] Start on new line*

If enabled the macro always starts on a new line when added to the transmit window.

## Definition

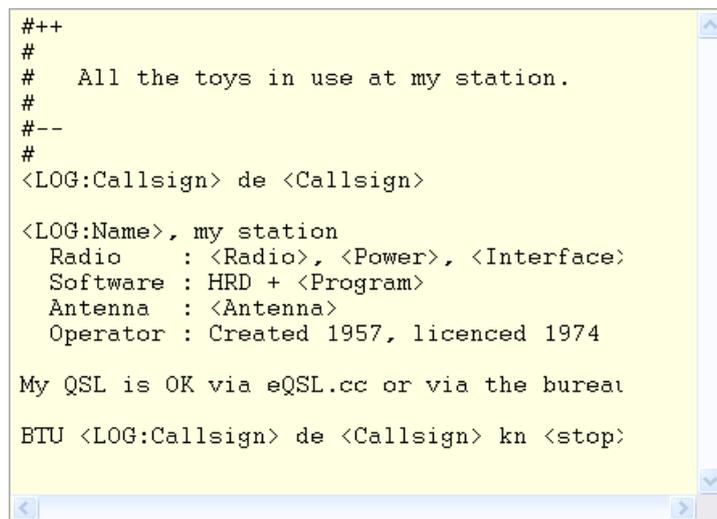

```
#++
#
#   All the toys in use at my station.
#
#--
#
<LOG:Callsign> de <Callsign>

<LOG:Name>, my station
  Radio   : <Radio>, <Power>, <Interface>
  Software : HRD + <Program>
  Antenna  : <Antenna>
  Operator : Created 1957, licenced 1974

My QSL is OK via eQSL.cc or via the bureau

BTU <LOG:Callsign> de <Callsign> kn <stop>
```

A macro contains free-format text and optional tags. A tag is an item of information, for example *his callsign* or your output *power*.

To insert a tag just double-click on an entry on one of the tag lists.

The currently supported tags are shown at the bottom of the editor window. There are three lists:

1. *Tags (My Info)*  
These fields come from the *Tags* window in the QSO windows.
2. *Logbook (His Info)*  
These fields come from the *Add Log Entry* window.
3. *Special*  
These are pre-defined.

A tag is enclosed in <>. The actual substitution is made when the macro is selected into the transmit window.

Tags (My Info)	Logbook (His Info)	Special	Description
Callsign	LOG:Callsign	date	date (local, ISO)
Name	LOG:Name	time	time (local, ISO)
Age	LOG:QTH	date_utc	date (UTC, ISO)
Locator	LOG:Locator	time_utc	time (UTC, ISO)
QTH	LOG:Frequency	time_hhmm	time (UTC, HHMM)
E-Mail	LOG:Band	add-log	add to logbook
HomePage	LOG:Mode	reset-log	reset logbook
Clubs	LOG:Sent	erase	erase window
Radio	LOG:Sent_Rpt	repeat	enable repeats
Antenna	LOG:Sent_Exch	stop	stops sending
Power	LOG:Rcvd		

## Special Tags

More information about the special tags.

date	Inserts the current date using local time and the user's Windows settings for short dates.
time	Inserts the current time using local time in ISO 8601 format (HH:MM:SS).
date_utc	Inserts the current date using UTC (GMT) time and the user's Windows settings for short dates.
time_utc	Inserts the current time using UTC (GMT) time in ISO 8601 format (HH:MM:SS).
Time_hhmm	Inserts the current time using UTC and the HHMM format.
add-log	The same as pressing the <i>Add</i> button in the <i>Add Log Entry</i> window – the QSO is added to the logbook.
Reset-log	The same as pressing the <i>Reset</i> button in the <i>Add Log Entry</i> window = the window contents are reset.
erase	Erases the transmit window.
repeat	The same as pressing the Repeat button.
stop	Stops sending.

## Radio Control

A radio control macro contains commands sent to Ham Radio Deluxe to configure your radio, for example to set a special filter. The text in the definition is not added to the input (TX) window. These definitions are specific to the radio you are using.

The tag `{{RADIO-CONTROL` must appear anywhere in the macro definition. If you have added this by mistake just remove the lines containing the tag.

The easiest way to add entries is to use the Radio window, as you select options in the Radio window the options are sent to Ham Radio Deluxe and the corresponding text is added to the definition (remember to press the Connect button in the Radio window). Only add one entry per line.

As with all macros lines starting with # are treated as comments and are not passed to Ham Radio Deluxe. Blank lines are ignored.

### Commands

There are four command types:

- Center frequency on/off,

- Dropdown (menu) buttons,
- Normal press buttons,
- Sliders.

To simplify the command parsing any spaces in the button / slider names are replaced with a tilde (~). Slider entries contain the radio title, this is for historical reasons.

### Center Frequency

- center-on
- center-on 1750
- center-off

To enable the current center frequency option in the waterfall enter `center-on`.

Note: the center frequency option must be enabled (checked). To specify the center frequency just add the frequency in Hz after the center-on tag, for example `center-on 1750`.

To undo the center frequency option and restore the previous radio frequency enter `center-off`.

The center-on and center-off text must be the only entry on the line. Typically you combine these options with a filter setting, for example when enabling the center frequency option a narrow filter is selected, when undoing a normal (wide) filter is selected.

```

###
#
#  {{RADIO-CONTROL
#
#  For the TS-2000
#
#  Set the center frequency to 1250Hz, adjust DSP filtering
#  to Low = 1000Hz, High = 1400Hz.
#
#--

center-on 1300
Set slider-pos TS-2000 DSP~low~cut 11 // DSP low cut = 11
Set slider-pos TS-2000 DSP~high~cut 0 // DSP high cut = 0

```

### Dropdown-Button

When you select an entry from a dropdown button it is added to the end of the definition. Existing entries for the same dropdown button are not overwritten as a dropdown button can contain unrelated commands.

### Press Button

When you press a button the editor first tries to replace an existing entry for this button; if there is no entry then a new entry is added to the end of the definition.

## Sliders

When you move a slider the editor first tries to replace an existing entry for this slider; if there is no entry then a new entry is added to the end of the definition.

## Video ID

A popular and most useful option is sending text at the beginning of you transmission where the text is displayed on the other station's waterfall.

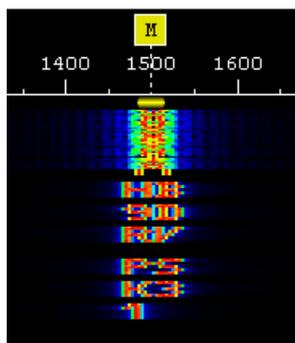

Here the test HB9DRV PSK31 is being sent to identify the transmission mode.

To add video text at the start of the macro add `<ident:HB9DRV PSK31>`, this must be the first test in the macro.

Here is an example where 73 is sent using Video ID when signing off:

```
#++
#
#   The end of the QSO, 73 and thanks for the QSO.
#
#--
#
<ident:73>
<LOG:Callsign> de <Callsign> 73 ...
```

An alternative to adding a video ID to a macro is to use the Video ID button in the transmit window (which must be enabled in the Program Options page QSO:Transmit).

---

## Preview

The macro is displayed *as it will be sent* when the cursor is placed over an entry in the macros window or macros toolbar.

In the example below the cursor is over the Station button. Text derived from tags is shown in italics.

Him de Me Pse K Report, Name, QTH Station 73 73-Xmas

*GD4ELI de hb9drv*

*Simon Brown, my station*

Radio : *TS-480SAT, 40W*  
Software : *DM780 v1.0 Beta*  
Antenna : *Diamond CP-6*  
Home : *www.hb9drv.ch*  
Other : *Created 1957, licenced 1974, RSGB, ARRL, G-QRP*

My QSL is OK via eQSL.cc or via the bureau.

BTU *GD4ELI de hb9drv K*

**Ctrl+7, Erase TX window**



# Program Options

DM780 is a fully featured program with many displays; as a result the level of user customization is very extensive.



You can customize almost every part of DM780 by selecting *Program Options* from the *Tools* menu.

The Programs Options window is modeless – while it is displayed you can still use DM780, also any changes you make are applied immediately.

## eQSL.cc

The integrated logbook will automatically upload new contacts to eQSL.cc if enabled here.

eQSL.cc

eQSL.cc

Upload when an entry is added to the logbook. Results are shown in the logfile.

Username: \*

Password: \*

QSL message:

\* = required  Use eQSL.cc test account

[Visit eQSL.cc](#)

---

## Themes And Skins

The Theme and Skinning panes define the appearance of DM780. Although the defaults should be acceptable there is no harm in selecting an appearance you find more appealing.

---

Skins add an extra load on your CPU and graphics card, so if you are using an older PC (less than 1 GHz CPU) you may consider disabling skins.

---

---

## Storage

This pane provides easy access to the file and registry storage used by DM780. The folder names depend on the currently selected identity (page 77).



Don't mess around with the registry – if you don't know what you are doing leave it alone!

---

Storage

Installation Folder (Executable, DLLs, Defaults, ...)  
D:\Ham Radio\Digital Master\Release\  
Browse

Local Storage Folder (Your files)  
C:\Documents and Settings\Simon.HAIRY-CREATURES\Application ...\Digital Master 780 ID {42-72-6F-77-73-65-72-54-65-73-74}\  
Browse

Current Logfile  
C:\Documents and Settings\Simon.HAIRY-CREATURES\Application Data\Simon Brown, HB..\DMLogfile\_05-May-2008 100018.txt  
View

Registry Key  
HKEY\_CURRENT\_USER\Software\Simon Brown\Digital Master\Options ID {42-72-6F-77-73-65-72-54-65-73-74}  
Regedit Text File

# Radio Interface

The radio interface configuration is described in the section Radio Control on page 16.

## Favourites

Use favourite frequencies to switch between commonly used digital mode frequencies.

### Manager

From the toolbar select *Manager* from the *Favourites* menu:

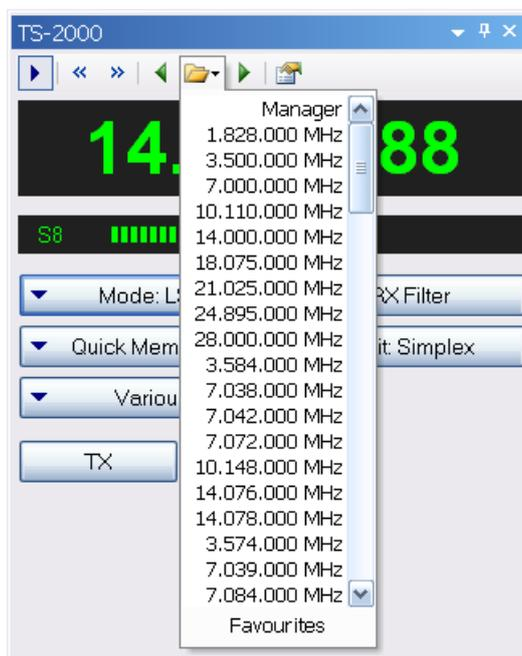

The favourites manager is a simple list of frequencies that are displayed in the dropdown menu and in the favourites toolbar in the QSO transmit windows.

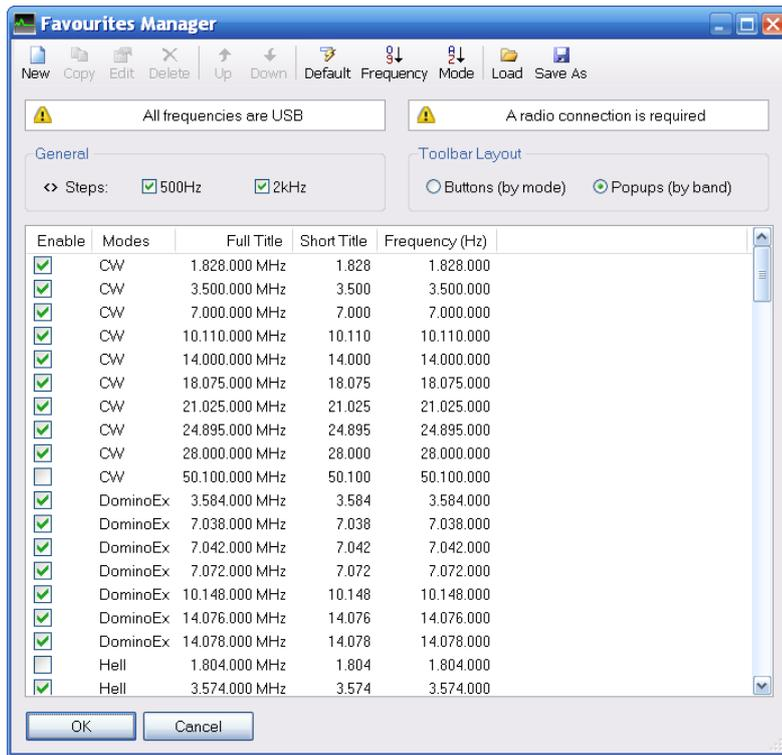

Options are selected from the toolbar.

## Editing

Editing is simple – a definition consists of a title, a short title (used in toolbars), the frequency in Hertz and the modes which use the definition.

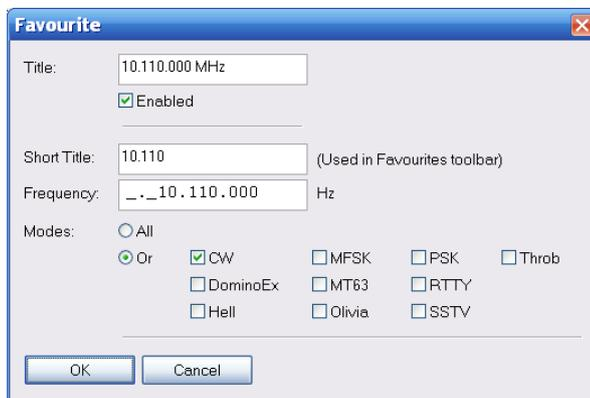

# Release Notes

The release notes page is selected from the *Help* menu. It contains a detailed list of changes together with the change date.

## Release Notes

### Build Numbers

The release notes are updated as changes are made, not every time a new build is created. When you download a kit it is very normal for there to be no notes for the same build number you have downloaded, so just look at the notes for previous builds.

The build number is in fact the number of days since May 1st, 2003 - the day when the first line of Ham Radio Deluxe source code was written.

So if the release notes are updated on Saturday August 4th, 2007 but the kit is built on Sunday August 5th, 2007 the most recent notes will be for build 1560 (Saturday), not 1561 (Sunday).

Version	Date
1.1 build 1832	May 2nd, 2008

#	Type	Description
1	Change	The logic for the Next / Prev favourite buttons in the radio display and radio toolbar has been changed to try and show the next / previous value for the current mode.  This is not an exact science as there can be more than one mode active at a time, but anyway it's an attempt at least!

Version	Date
1.1 build 1832	May 2nd, 2008

#	Type	Description
1	Change	Alarms window logic reworked to ensure new entries are displayed and highlighted, windows also made resizable (this includes the Alarms Test window).
2	Change	The SuperBrowser QSO window now remembers its own squelch value rather than inheriting the general SuperBrowser value.
3	Fix	When using the Video ID option with Olivia the current bandwidth / tones is now displayed.
4	Change	If an image cannot be displayed in the SSTV folders (maybe it's corrupted) then a small red cross is displayed to indicate a bad image (as Windows does in various



# Various

A few other options worthy of mention are discussed here.

## Time Synchronisation

DM780 has a built-in NTP Client for exact time synchronisation.

Select Time Synchronisation from the Tools menu.



Select the update frequency – every 6 hours should be fine.

Select three time servers; these will be tried in turn until one of them returns valid data.

Press Test to test the corresponding server. The logfile window shows output similar to that below.

```
10:50:32 NTP Client: Server address = time.windows.com
10:50:32 NTP Client: Server address = 207.46.197.32, port =
123
10:50:32 NTP Client: Receive port = 7123
10:50:32 NTP Client: Receive timeout = 10 seconds
10:50:32 NTP Client: Request sent
10:50:32 NTP Client: Reply received
10:50:32 NTP Client: Client ...: 08:50:32.392 UTC/GMT
10:50:32 NTP Client: Server ...: 08:50:32.405 UTC/GMT
10:50:32 NTP Client: Offset ...: 13 milliseconds
10:50:32 NTP Client: Computer time updated
```

Your Windows account must have the system-time privilege to be able to update the computer time.

---

# WWV Updates

From the Tools menu look at the WWV menu to enable display of Space Weather and Sunspot Data in the status bar.





# Index

## A

Add Log Entry, 20, 22, 23  
 ADIF, 55  
 Advanced QSO Options, 27  
 AFC, 27  
 Alarms, 71, 78  
 Apple, 8  
 Audio Interfacing, 11

## C

Cabrillo, 58  
 Callsign Lookup, 22, 51  
 Center Frequency, 30  
 Change frequency, 31  
 COM Port, 18  
 Creative Audigy, 14  
 CW, 7

## D

DigiMaster, 11  
 DIY interface, 12  
 DominoEx, 7

## E

Edirol FA-66, 8  
 eQSL.cc, 55, 89  
*Escape*, 21

## F

Favourites, 78, 91  
 Favourites Manager, 91  
 Favourites Toolbar, 31  
 Fldigi, 8  
 FTP, 48

## G

G4ZLP, 11  
 Getting Started, 11  
 Google, 23  
 Google Earth, 59  
 Greyscale, 69

## H

Ham Radio Deluxe, 7, 18

Hardware Requirement, 8  
 Hellschreiber, 7  
 HRD IP Server, 16

## I

Identities, 77

## K

Keyhole Markup Language, 59  
 kml, 59

## L

Layout, 55  
 Linux, 8  
 Logbook, 53  
 Logbook Analysis, 60  
 Logbook of The World, 55  
 Logfile, 79

## M

Mac, 8  
 Macintosh, 8  
 Macros, 20, 78, 81  
 Macros Manager, 81  
 Main Logbook, 54  
 Main Toolbar, 29  
 Markers, 29, 31  
 Martin Lynch, 2  
 M-Audio Delta 44, 8, 14  
 Merge HRD Logbook, 58  
 MFSK, 7  
 Mode, 20  
 Modes, 20  
 Modes Toolbar, 31  
 MT63, 7  
 Multi-Channel Support, 27  
 My Station, 26

## N

*NIDQ*, 65  
 Navigator, 8, 11, 14

## O

Olivia, 8  
 Operating System Support, 8

## P

*Philip Gladstone*, 65  
Program Options, 89  
PSK Propagation Reporter, 65  
PSK31 Deluxe, 7  
PSK31 signals, 20  
PTT, 17

## Q

QRZ.com, 22, 51  
QSO window, 19  
QSO Window, 19  
Quick Log, 53

## R

Radio Control, 16  
Radio Interface, 91  
Receive window, 20  
Receiving Images, 43  
Regular expression syntax, 73  
Release Notes, 93  
Repeats, 28  
RIGBlaster, 12  
RTTY, 8

## S

Signal Quality, 27  
SignalLink, 11  
SignalLink USB, 8, 14  
Skins, 90  
soundcard, 14  
Soundcard, 13, 18  
Soundcard Calibration, 42  
Sourcecode, 8  
Special Tags, 85  
Split Mode, 28  
Squelch, 27  
SSTV, 7, 41  
Storage, 90  
SuperBrowser, 61  
Support forums, 9

Supported Modes, 7

## T

Tags, 13, 20, 78  
  Multiple, 13  
Template Editor, 45  
Test Transmission, 21  
Text-To-Speech, 75  
Themes, 90  
Throb, 8  
Tigertronics, 11  
Time Synchronisation, 95  
Transmit window, 20  
Transmitting, 21, 44  
TS-480SAT, 2, 8, 17  
*TX* push button, 17

## U

Using Macros, 22  
USInterface, 14  
USInterface.com, 11

## V

VISTA, 8  
VOX, 18

## W

W1HKJ, 8  
Waterfall, 20, 28  
Web Browsers, 67  
West Mountain Radio, 12  
Windows 2000, 8  
Windows 98, 8  
Windows VISTA, 8  
Windows XP, 8  
WINE, 8  
World Map, 69  
WWV Updates, 96

## Z

ZLP, 11



---

**SIMON BROWN**  
**HB9DRV**

Postfach 159  
7031 Laax  
Switzerland

[simon@hb9drv.ch](mailto:simon@hb9drv.ch)